

HANDLES COLLECTION

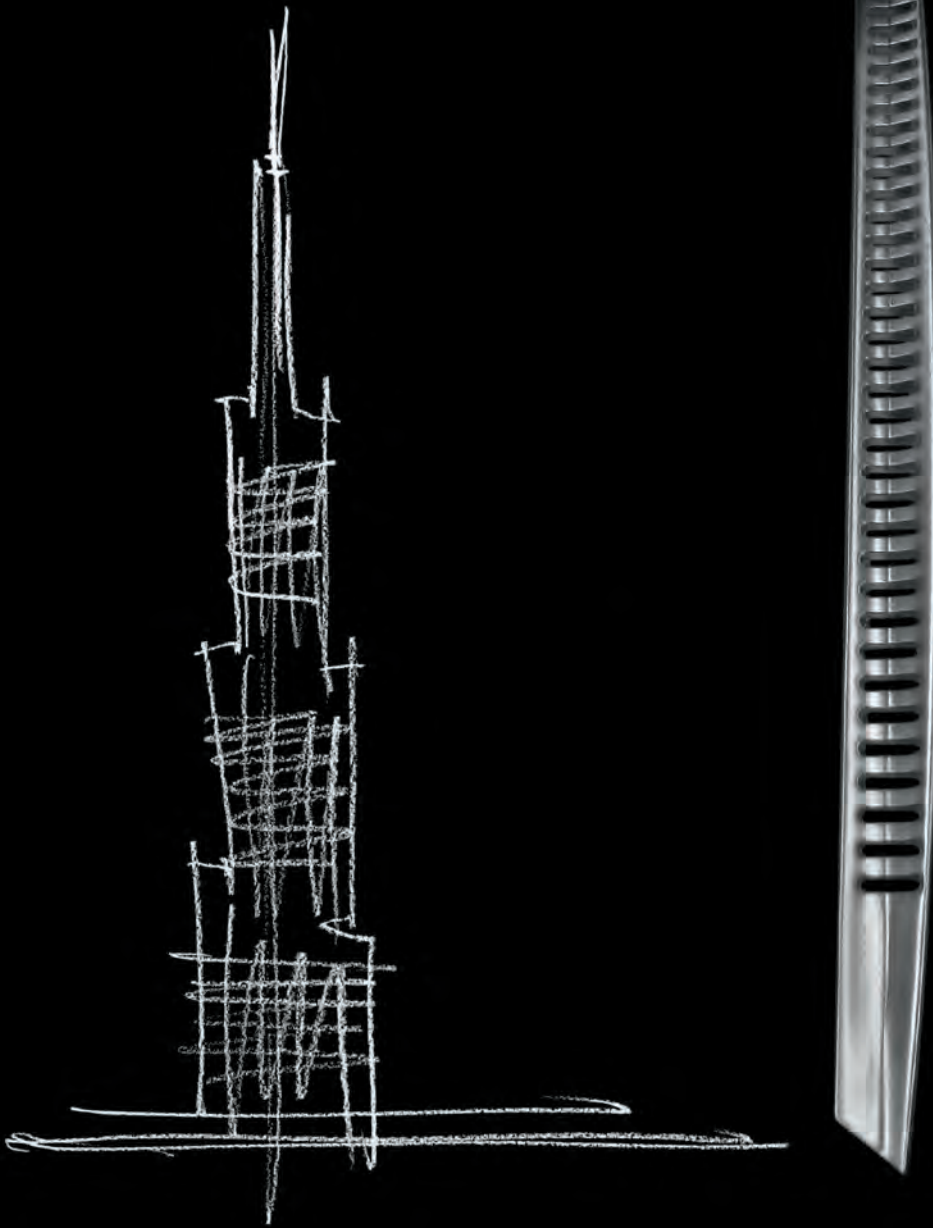

rds

made in Italy



GIARA

Giara è il frutto della passione che Ruggero Frascio, Emanuela Pasini e i figli Giacinto e Raffaele dedicano alla loro attività: ideare e produrre maniglie e complementi per arredamento.

Le quattro collezioni GIARA ART DESIGN, KLEIS, RDS e BRONZE rappresentano quattro mondi, quattro modi di intendere l'architettura dove la maniglia diventa il complemento per donare alle opere quel dettaglio che ne rivela tutta la loro grandezza.

Giara is the fruit of the passion that Ruggero Frascio, Emanuela Pasini and their children Giacinto and Raffaele dedicate to their business: to design and produce handles and furnishing accessories.

The four collections GIARA ART DESIGN, KLEIS, RDS and BRONZE represent four worlds, four ways of understanding the architecture where the handle becomes the complement to give to the works that detail that reveals all their greatness.

Giara ist die Frucht der Leidenschaft, die Ruggero Frascio, Emanuela Pasini und ihre Söhne Giacinto und Raffaele ihrer Arbeit widmen: Griffe und Einrichtungsaccessoires zu entwickeln und herzustellen.

Die vier Kollektionen GIARA ART DESIGN, KLEIS, RDS und BRONZE stellen vier Welten dar; vier Welten die die Architektur auf unterschiedliche Art und Weise verstehen und in denen der Griff zu jenem Detail wird, das die Größe der Kunstwerke in vollem Umfang preisgibt.

Giara est le fruit de la passion que Ruggero Frascio, Emanuela Pasini et leurs enfants Giacinto et Raffaele ont consacré à leur activité : concevoir et fabriquer des poignées et des accessoires de décoration.

Les quatre collections GIARA ART DESIGN, KLEIS, RDS et BRONZE représentent quatre mondes, quatre manières de comprendre l'architecture dans lesquelles la poignée devient l'accessoire pour offrir aux œuvres ce détail qui en révèle toute leur grandeur.



KLEIS

RDS

BRONZE

Handles Collection



OLA

design Marcello Cutino BCF

4-7



DINAMICA

design Ivo Pellegri

8-11



SKYLINE

design Marcello Cutino BCF

12-15



KAPPA

design Enrico Cattaneo

16-19



ARCO

design Marcello Cutino BCF

20-23



BRUGES

design Studio RDS

24-27



COMPATTA

design Ivo Pellegri

28-31



DENVER

design Elias Segù

32-35



ELBA

design Giovanni Amalfitano

36-39



MILANO

design Ivo Pellegri

40-43



MILANO quadra

design Ivo Pellegri

44-47



ODESSA

design Maurizio Duranti

48-51



VERONA

design Studio RDS

52-55



VERONA quadra

design Studio RDS

56-59



VIESTE

design Ivo Pellegri

60-63

Accessori

Accessories / Zubehör / Accessoires

65

Finiture

Finishes / Veredelungen / Finitions

103

Come ordinare e comporre il codice di acquisto

How to order and settle the purchase code

Bestellen und den Kaufcode erstellen

Comment commander et composer le code d'achat

vedi pag.

see page / Siehe Seite / voir pag.

64





RDS. UN MONDO DI MANIGLIE

Una gamma di maniglie caratterizzate da grande cura nella forma e nella realizzazione. La modellistica si inserisce con creatività in diversi contesti architettonici – classici o contemporanei – e di interior design, nel più autentico stile Made in Italy.

A WORLD OF HANDLES

A range of handles with a focus on form and beauty of creation. Modelling is an essential part of creativity in a number of classical and contemporary architectural contexts, as well as in interior design, in the most authentic "Made in Italy" tradition.

DIE GANZE WELT DER DRÜCKER

Ein Drückersortiment mit Fokus auf Form und Schönheit. Die Modelle integrieren sich auf kreative Weise in unterschiedlichen architektonischen Kontext – klassisch oder zeitgeistig. Jedoch immer in der authentischen Tradition von „Made in Italy“.

UN MONDE DE POIGNÉES

Une gamme de poignées avec un accent sur la forme et la beauté de la création. La modélisation est une partie essentielle de la créativité dans un certain nombre de contexte architectural classique et contemporaine, ainsi que dans le Design d'intérieurs, dans la tradition la plus authentique du « Made in Italy ».





Ola.

design Marcello Cutino BCF

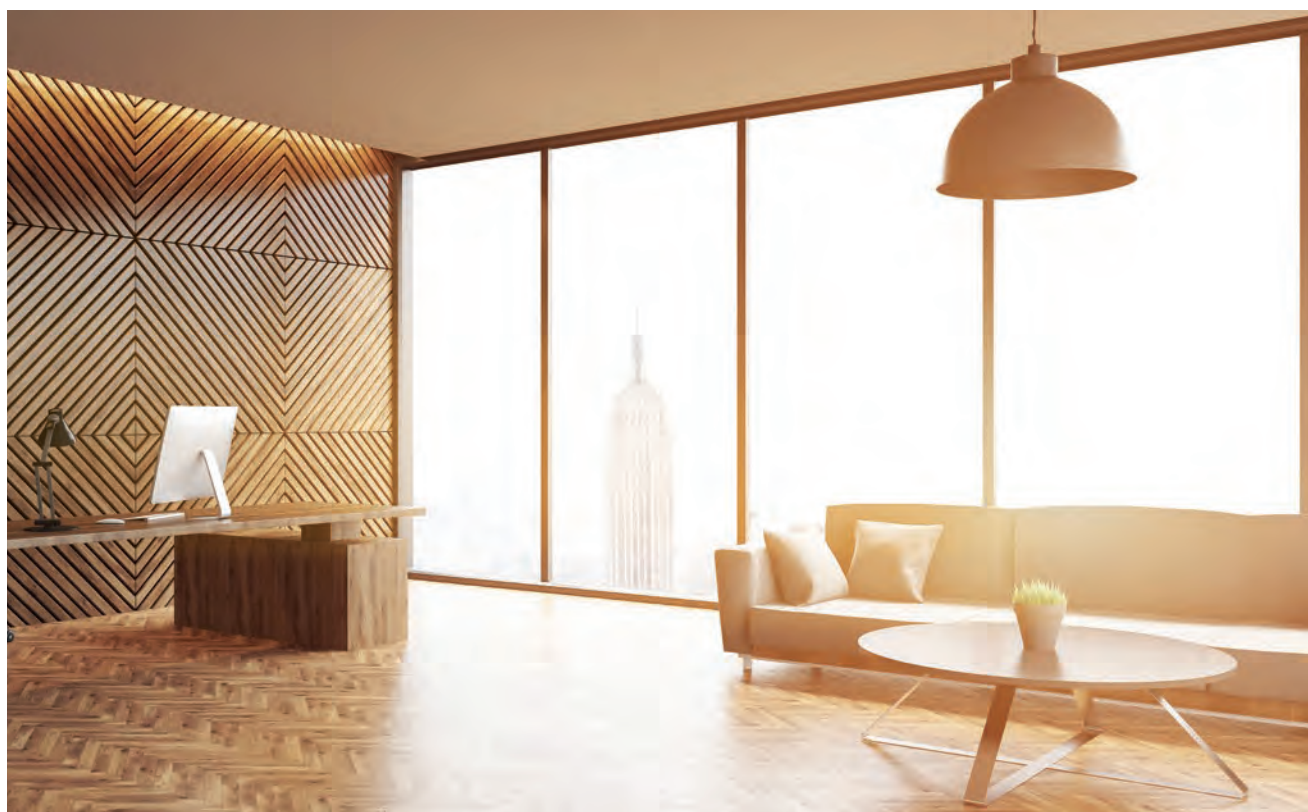
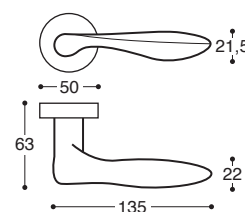

materiale / material
Ottone / Brass
standard
finiture standard / standard finishes

o0 - Oro
 Polished brass

o6 - Cromo lucido
 Polished chrome

o8 - Cromo satinato
 Satin chrome

BA - Bronzo gr. opaco
 Mat satin bronze

finiture trendy / trendy finishes

G3 - Gun metal

15 - Nero opaco*
 Mat black*

16 - Bianco*
 White*

ROLA60
 S/bocchetta / Latch

ROLA62
 Patent / Lock

ROLA64
 Yale / Cylinder

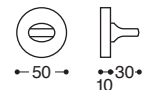
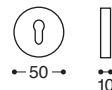
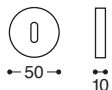
ROLA66
 WC / Privacy - Q. 6/7/8

Ola/HB14 Rosetta metallo&plastica - con molla / Metal&plastic rose - springloaded

ROLAS0
 S/bocchetta / Latch

ROLAS2
 Patent / Lock

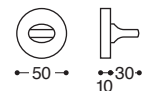
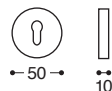
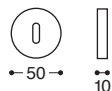
ROLAS4
 Yale / Cylinder

ROLAS6
 WC / Privacy - Q. 6/7/8

Ola/52D Rosetta metallo&plastica - con molla / Metal&plastic rose - springloaded

ROLAP0
 S/bocchetta / Latch

ROLAP2
 Patent / Lock

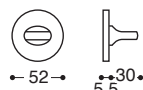
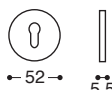
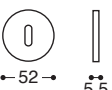
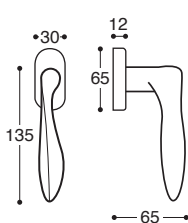
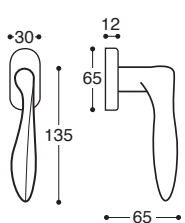
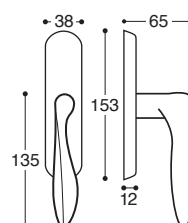
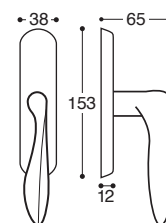
ROLAP4
 Yale / Cylinder

ROLAP6
 WC / Privacy - Q. 6/7/8

Ola/FLT Rosetta ribassata metallo - con molla / Metal flat rose - springloaded

ROLA6J
 SX / LH

ROLA6I
 DX / RH

ROLA6L
 SX / LH

ROLA6K
 DX / RH

Ola DK - mov. 8 scatti
 Window handle - 8 pos. mech.

Ola Martellina Per finestra - cremonese
 mov. escluso/ For window - cremon - mec. non included

* a richiesta / on demand

Material / material
 Messing / Brass

standard

Standardveredelungen / standard finishes

o0 - Messing poliert
 Polished brass

o6 - Chrom
 Polished chrome

o8 - Chrom matt
 Satin chrome

BA - Matt Satin Bronze
 Mat satin bronze

Trendy Veredelungen / trendy finishes



G3 - Gun metal

15 - Matt schwarz*
 Mat black*

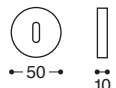
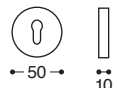
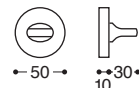
16 - Weiß*
 White*

ROLAS0
 Ohne Schlüssel / Latch

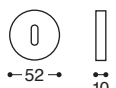
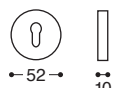
ROLAS3
 BB / Lock

ROLAS5
 PZ / Cylinder

ROLAS7
 BAD S. 6/7/8 / Privacy

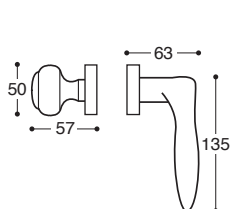
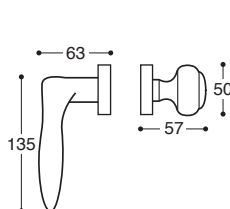
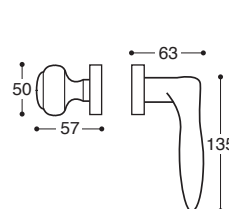
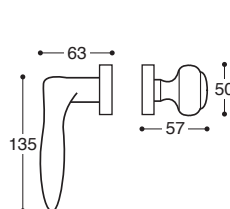
Ola/52D Metall/Kunststoff Rosetten DIN 38 mm - Mit Feder / Metal&plastic rose - springloaded

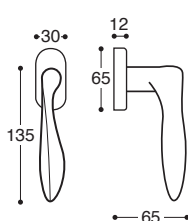
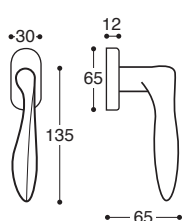
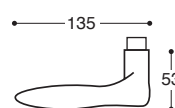
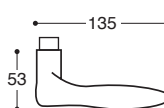
ROLA10
 Ohne Schlüssel / Latch

ROLA13
 BB / Lock

ROLA15
 PZ / Cylinder

ROLA17
 BAD S. 6/7/8 / Privacy

Ola/T11 Metall Rosetten DIN 38 mm - Mit Feder / Metal rose - springloaded

ROLASD
 PZ, Links / LH

ROLASC
 PZ, Rechts / RH

ROLA1D
 PZ, Links / LH

ROLA1C
 PZ, Rechts / RH

Ola/52D Metall/Kunststoff Rosetten Wechselgarnitur
Ola/T11 Metall Rosetten Wechselgarnitur

ROLA6J
 Links / LH

ROLA6I
 Rechts / RH

ROLA09
 Links / LH

ROLA08
 Rechts / RH

Ola DK Fenstergriffe - Mit Rastung
 Window handle - 8 pos. mech.

Ola
 Drückerlochteil - Ohne Rosetten

* auf Anfrage / on demand

matériau / material
 Laiton / Brass

standard

finitions standards / standard finishes

00 - Laiton poli
 Polished brass

06 - Chrome poli
 Polished chrome

08 - Chrome satiné
 Satin chrome

BA - Bronze mat satiné
 Mat satin bronze

finitions trendy / trendy finishes



G3 - Gun metal

15 - Noir mat*
 Mat black*

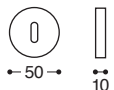
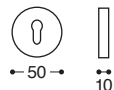
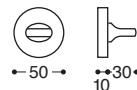
16 - Blanc*
 White*

ROLA6S
 BDC / Latch

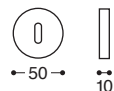
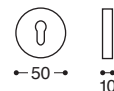
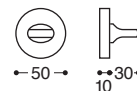
ROLA6P
 Cle L / Lock

ROLA6Y
 Cle I / Cylinder

ROLA6W
 Cond/Dec C. 6/7/8 / Privacy

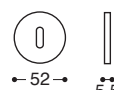
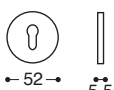
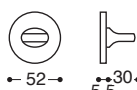
Ola/HB14 Métal et plastique rosace - avec ressort, carré 7 mm
 Metal&plastic rose - springloaded

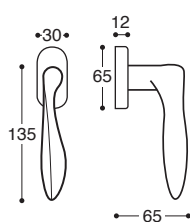
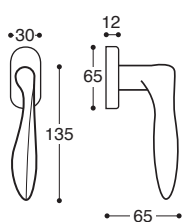
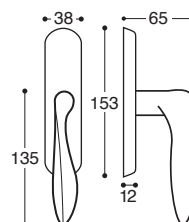
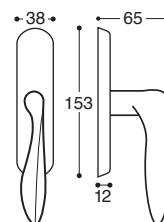
ROLASS
 BDC / Latch

ROLASP
 Cle L / Lock

ROLASY
 Cle I / Cylinder

ROLASW
 Cond/Dec C. 6/7/8 / Privacy

Ola/52D Métal et plastique rosace - avec ressort, carré 7 mm / Metal&plastic rose - springloaded

ROLAPS
 BDC / Latch

ROLAPP
 Cle L / Lock

ROLAPY
 Cle I / Cylinder

ROLAPW
 Cond/Dec C. 6/7/8 / Privacy

Ola/FLT Rosette abaissée métal - avec ressort, carré 7 mm / Metal flat rose - springloaded

ROLA6J
 Gauche / LH

ROLA6I
 Droite / RH

ROLA6L
 Gauche / LH

ROLA6K
 Droite / RH

Ola DK Poignée de fenetre
 Mécan. 8 positions / Window handle - 8 pos. mech.

Ola Martellina Poignée de fenetre - crémona
 Mécan. exclus / For window - cremon - mec. non included

* sur demande / on demand



Dinamica.

design Ivo Pellegrini

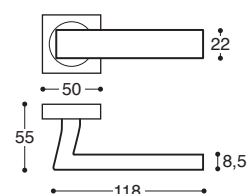

materiale / material
Ottone / Brass

standard

finiture standard / standard finishes



00 - Oro
Polished brass



06 - Cromo lucido
Polished chrome



08 - Cromo satinato
Satin chrome



33 - Nickel satin. verniciato
Satin nickel



BA - Bronzo gr. opaco
Mat satin bronze

finiture trendy / trendy finishes



G3 - Gun metal



15 - Nero opaco*
Mat black*



16 - Bianco*
White*

* a richiesta / on demand

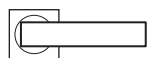

RDIN50
S/bocchetta / Latch

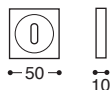
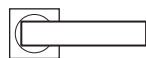

RDIN52
Patent / Lock

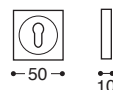

RDIN54
Yale / Cylinder

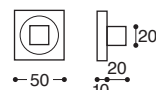

RDIN56
WC / Privacy - Q. 6/7/8

Dinamica/Quad Rosetta metallo - con molla / Metal rose - springloaded

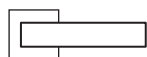

RDINB0
S/bocchetta / Latch

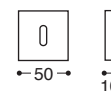
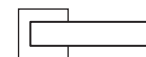

RDINB2
Patent / Lock

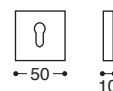
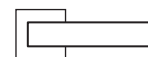

RDINB4
Yale / Cylinder

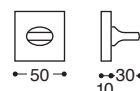
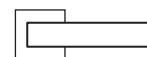

RDINB6
WC / Privacy - Q. 6/7/8

Dinamica/50x50 Rosetta metallo&plastica - con molla / Metal&plastic rose - springloaded

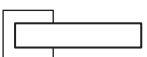

RDINF0
S/bocchetta / Latch

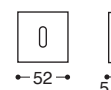

RDINF2
Patent / Lock

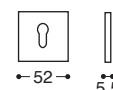
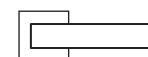

RDINF4
Yale / Cylinder

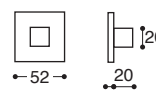
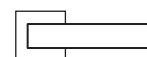

RDINF6
WC / Privacy - Q. 6/7/8

Dinamica/FLQ Rosetta ribassata metallo - con molla / Metal flat rose - springloaded

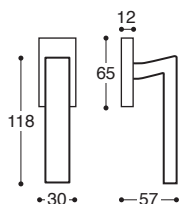

RDIN51
Senza mano / Without hand

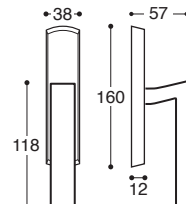

RDIN5K
Senza mano / Without hand

Dinamica DK - mov. 8 scatti
Window handle - 8 pos. mech.

Dinamica Martellina Per finestra - cremonese
mov. escluso / For window - cremon - mec. non included

Material / material
Messing / Brass

standard

Standardveredelungen / standard finishes



00 - Messing poliert
Polished brass



06 - Chrom
Polished chrome



08 - Chrom matt
Satin chrome



33 - Nickel matt
Satin nickel



BA - Matt Satin Bronze
Mat satin bronze

Trendy Veredelungen / trendy finishes



G3 - Gun metal



15 - Matt schwarz*
Mat black*



16 - Weiß*
White*

* auf Anfrage / on demand

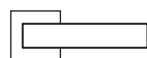

RDINB0
Ohne Schlüssel / Latch

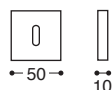
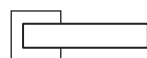

RDINB3
BB / Lock

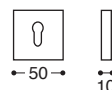

RDINB5
PZ / Cylinder

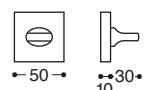
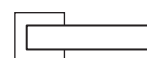

RDINB7
BAD S. 6/7/8 / Privacy

Dinamica/50x50 Metall/Kunststoff Rosetten DIN 38 mm - Mit Feder
Metal&plastic rose - springloaded

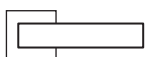

RDINV0
Ohne Schlüssel / Latch

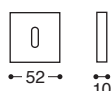

RDINV3
BB / Lock

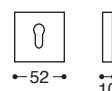

RDINV5
PZ / Cylinder

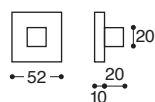

RDINV7
BAD S. 6/7/8 / Privacy

Dinamica/Q11 Metall Rosetten DIN 38 mm - Mit Feder / Metal rose - springloaded

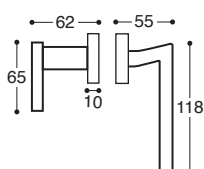

RDINBD
PZ, Links / LH

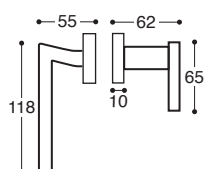

RDINBC
PZ, Rechts / RH

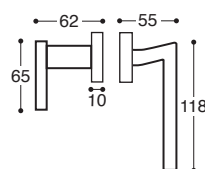

RDINVD
PZ, Links / LH

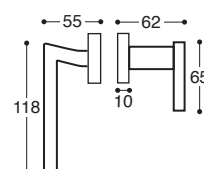

RDINVC
PZ, Rechts / RH

Dinamica/50x50 Metall/Kunststoff Rosetten - Wechselgarnitur

Dinamica/Q11 Metall Rosetten - Wechselgarnitur

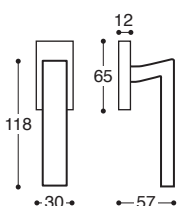

RDIN51
Ohne Hand / Without hand

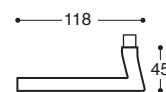

RDIN09
Links / LH

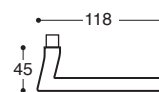

RDIN08
Rechts / RH

Dinamica DK Fenstergriffe
Mit Rastung / Window handle - 8 pos. mech.

Dinamica
Drückerlochteil - Ohne Rosetten

matériau / material
Laiton / Brass

standard

finitions standards / standard finishes



00 - Laiton poli
Polished brass



06 - Chrome poli
Polished chrome



08 - Chrome satiné
Satin chrome



33 - Nickel satiné
Satin nickel



BA - Bronze mat satiné
Mat satin bronze

finitions trendy / trendy finishes



G3 - Gun metal



15 - Noir mat*
Mat black*



16 - Blanc*
White*

* sur demande / on demand

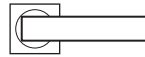

RDIN5S
BDC / Latch

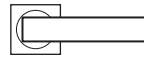

RDIN5P
Cle L / Lock

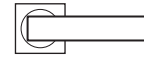

RDIN5Y
Cle I / Cylinder



RDIN5W
Cond/Dec C. 6/7/8 / Privacy

Dinamica/Quad Métal rosace - avec ressort, carré 7 mm / **Metal rose** - springloaded

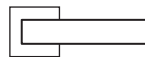

RDINBS
BDC / Latch



RDINBP
Cle L / Lock



RDINBY
Cle I / Cylinder



RDINBW
Cond/Dec C. 6/7/8 / Privacy

Dinamica/50x50 Métal et plastique rosace - avec ressort, carré 7 mm
Metal&plastic rose - springloaded

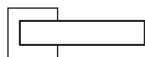

RDINFS
BDC / Latch

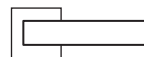

RDINFP
Cle L / Lock

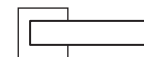

RDINFY
Cle I / Cylinder

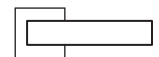

RDINFW
Cond/Dec C. 6/7/8 / Privacy

Dinamica/FLQ Rosette abaissée métal - avec ressort, carré 7 mm
Metal flat rose - springloaded

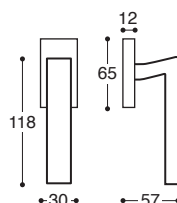

RDIN5I
Sans main / Without hand

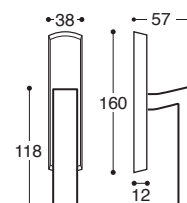

RDIN5K
Sans main / Without hand

Dinamica DK Poignée de fenêtre
Mécan. 8 positions / Window handle - 8 pos. mech.

Dinamica Martellina Poignée de fenêtre - crémon
Mécan. exclus / For window - cremon - mec. non include



Skyline.
design Marcello Cutino BCF

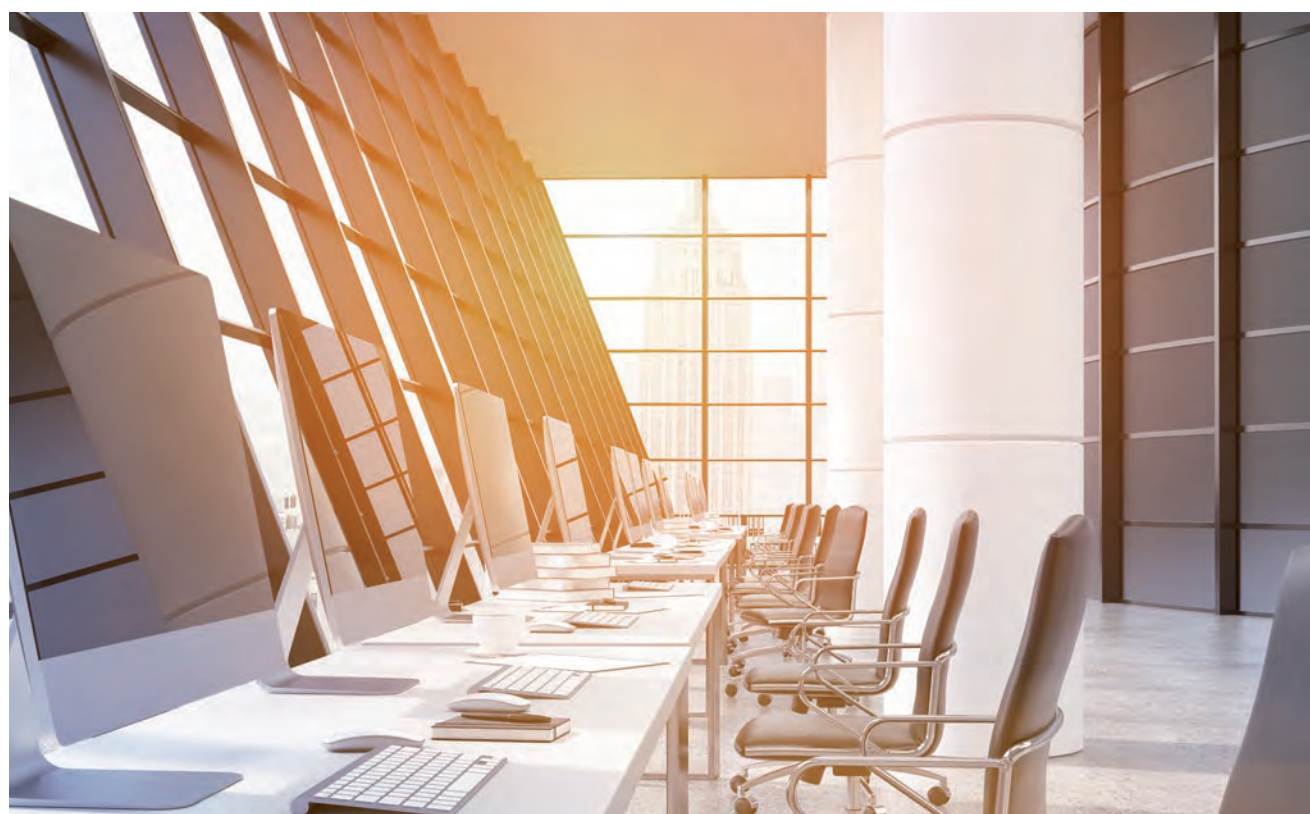
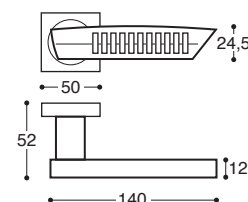

materiale / material
Ottone / Brass

standard

Skyline.
design Marcello Cutino BCF

finiture standard / standard finishes



o6 - Cromo lucido
Polished chrome



o8 - Cromo satinato
Satin chrome

finiture trendy / trendy finishes



G3 - Gun metal



15 - Nero opaco*
Mat black*



16 - Bianco*
White*

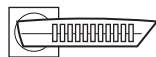

RSKY50
S/bocchetta / Latch

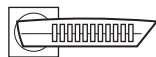

RSKY52
Patent / Lock

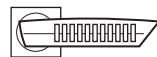

RSKY54
Yale / Cylinder



RSKY56
WC / Privacy - Q. 6/7/8



Skyline/Quad Rosetta metallo - con molla / **Metal rose** - springloaded



RSKYB0
S/bocchetta / Latch



RSKYB2
Patent / Lock



RSKYB4
Yale / Cylinder



RSKYB6
WC / Privacy - Q. 6/7/8



Skyline/50x50 Rosetta metallo&plastica - con molla / **Metal&plastic rose** - springloaded



RSKYF0
S/bocchetta / Latch



RSKYF2
Patent / Lock



RSKYF4
Yale / Cylinder



RSKYF6
WC / Privacy - Q. 6/7/8



Skyline/FLQ Rosetta ribassata metallo - con molla / **Metal flat rose** - springloaded

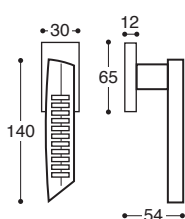

RSKY5J
SX / LH

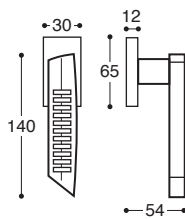

RSKY5I
DX / RH

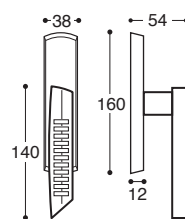

RSKY5L
SX / LH

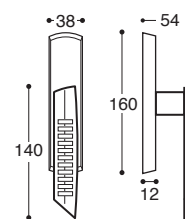

RSKY5K
DX / RH

Skyline DK - mov. 8 scatti
Window handle - 8 pos. mech.

Skyline Martellina Per finestra - cremonese
mov. escluso/ For window - cremon - mec. non included

* a richiesta / on demand

Material / material
 Messing / Brass

standard

Standardveredelungen / standard finishes

o6 - Chrom
 Polished chrome

o8 - Chrom matt
 Satin chrome

Trendy Veredelungen / trendy finishes

G3 - Gun metal

15 - Matt schwarz*
 Mat black*

16 - Weiß*
 White*

RSKYB0
 Ohne Schlüssel / Latch

RSKYB3
 BB / Lock

RSKYB5
 PZ / Cylinder

RSKYB7
 BAD S. 6/7/8 / Privacy

Skyline/50x50 Metall/Kunststoff Rosetten DIN 38 mm - Mit Feder
Metal&plastic rose - springloaded

RSKYV0
 Ohne Schlüssel / Latch

RSKYV3
 BB / Lock

RSKYV5
 PZ / Cylinder

RSKYV7
 BAD S. 6/7/8 / Privacy

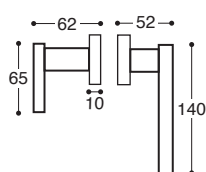
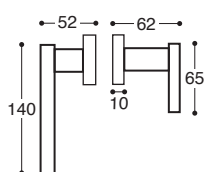
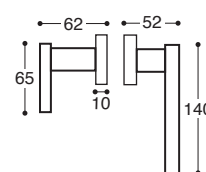
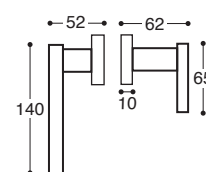
Skyline/Q11 Metall Rosetten DIN 38 mm - Mit Feder / Metal rose - springloaded

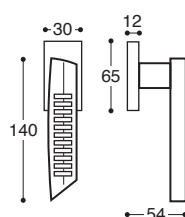
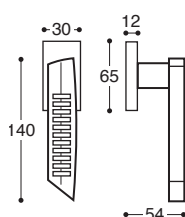
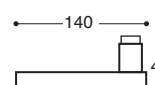
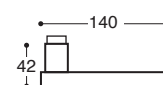
RSKYBD
 PZ, Links / LH

RSKYBC
 PZ, Rechts / RH

RSKYVD
 PZ, Links / LH

RSKYVC
 PZ, Rechts / RH

Skyline/50x50 Metall/Kunststoff Rosetten - Wechselgarnitur
Skyline/Q11 Metall Rosetten - Wechselgarnitur

RSKY5J
 Links / LH

RSKY5I
 Rechts / RH

RSKY09
 Links / LH

RSKY08
 Rechts / RH

Skyline DK Fenstergriffe - Mit Rastung
Window handle - 8 pos. mech.
Skyline Drückerlochteil - Ohne Rosetten

* auf Anfrage / on demand

matériau / material
Laiton / Brass

standard

Skyline.
design Marcello Cutino BCF

finitions standards / standard finishes



o6 - Chrome poli
Polished chrome



o8 - Chrome satiné
Satin chrome

finitions trendy / trendy finishes



G3 - Gun metal



15 - Noir mat*
Mat black*



16 - Blanc*
White*



RSKY5S
BDC / Latch



RSKY5P
Cle L / Lock



RSKY5Y
Cle I / Cylinder



RSKY5W
Cond/Dec C. 6/7/8 / Privacy

Skyline/Quad Métal rosace - avec ressort, carré 7 mm / **Metal rose** - springloaded



RSKYBS
BDC / Latch



RSKYBP
Cle L / Lock



RSKYBY
Cle I / Cylinder



RSKYBW
Cond/Dec C. 6/7/8 / Privacy

Skyline/50x50 Métal et plastique rosace - avec ressort, carré 7 mm
Metal&plastic rose - springloaded

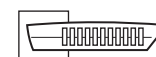

RSKYFS
BDC / Latch



RSKYFP
Cle L / Lock



RSKYFY
Cle I / Cylinder



RSKYFW
Cond/Dec C. 6/7/8 / Privacy

Skyline/FLQ Rosette abaissée métal - avec ressort, carré 7 mm / **Metal flat rose** - springloaded

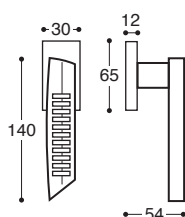

RSKY5J
Gauche / LH

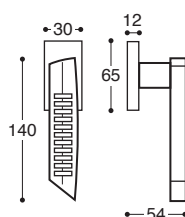

RSKY5I
Droite / RH

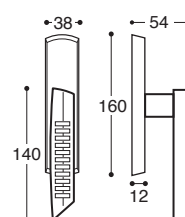

RSKY5L
Gauche / LH

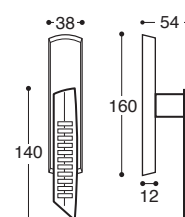

RSKY5K
Droite / RH

Skyline DK Poignée de fenêtre
Mécan. 8 positions / Window handle - 8 pos. mech.

Skyline Martellina Poignée de fenêtre - crémone
Mécan. exclus / For window - cremon - mec. non included

* sur demande / on demand



Kappa.

design Enrico Cattaneo

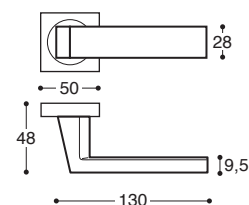

materiale / material
Ottone / Brass
standard
finiture standard / standard finishes

00 - Oro
 Polished brass

06 - Cromo lucido
 Polished chrome

08 - Cromo satinato
 Satin chrome

finiture trendy / trendy finishes

G3 - Gun metal

15 - Nero opaco*
 Mat black*

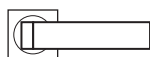
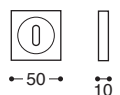
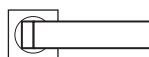
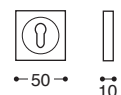
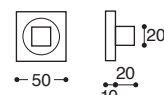
16 - Bianco*
 White*

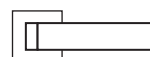
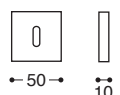
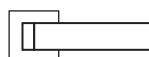
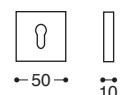
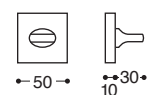
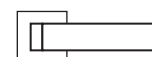
RKAP50
 S/bocchetta / Latch

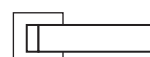
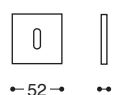
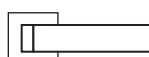
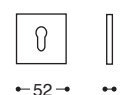
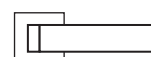
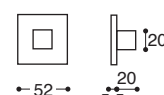
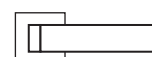
RKAP52
 Patent / Lock

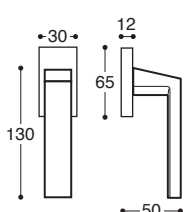
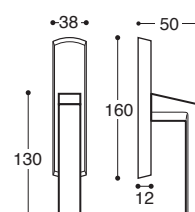
RKAP54
 Yale / Cylinder

RKAP56
 WC / Privacy - Q. 6/7/8

Kappa/Quad Rosetta metallo - con molla / Metal rose - springloaded

RKAPB0
 S/bocchetta / Latch

RKAPB2
 Patent / Lock

RKAPB4
 Yale / Cylinder

RKAPB6
 WC / Privacy - Q. 6/7/8

Kappa/50x50 Rosetta metallo&plastica - con molla / Metal&plastic rose - springloaded

RKAPF0
 S/bocchetta / Latch

RKAPF2
 Patent / Lock

RKAPF4
 Yale / Cylinder

RKAPF6
 WC / Privacy - Q. 6/7/8

Kappa/FLQ Rosetta ribassata metallo - con molla / Metal flat rose - springloaded

RKAP51
 Senza mano / Without hand

RKAP5K
 Senza mano / Without hand

Kappa DK - mov. 8 scatti
 Window handle - 8 pos. mech.

Kappa Martellina Per finestra - cremonese
 mov. escluso / For window - cremon - mec. non included

* a richiesta / on demand

Standardveredelungen / standard finishes



00 - Messing poliert
Polished brass



06 - Chrom
Polished chrome



08 - Chrom matt
Satin chrome

Trendy Veredelungen / trendy finishes



G3 - Gun metal



15 - Matt schwarz*
Mat black*



16 - Weiß*
White*

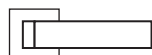

RKAPB0
Ohne Schlüssel / Latch

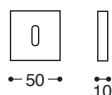
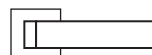

RKAPB3
BB / Lock

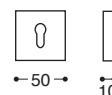

RKAPB5
PZ / Cylinder

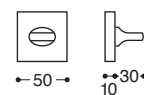
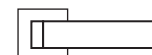

RKAPB7
BAD S. 6/7/8 / Privacy

Kappa/50x50 Metall/Kunststoff Rosetten DIN 38 mm - Mit Feder / Metal&plastic rose - springloaded

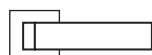

RKAPV0
Ohne Schlüssel / Latch

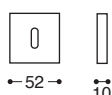
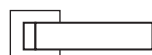

RKAPV3
BB / Lock

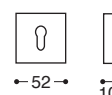
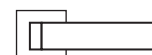

RKAPV5
PZ / Cylinder

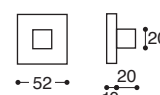
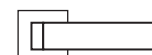

RKAPV7
BAD S. 6/7/8 / Privacy

Kappa/Q11 Metall Rosetten DIN 38 mm - Mit Feder / Metal rose - springloaded

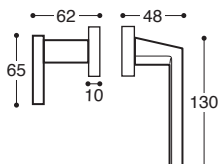

RKAPBD
PZ, Links / LH

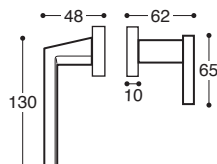

RKAPBC
PZ, Rechts / RH

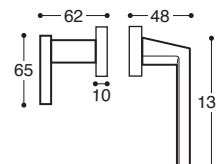

RKAPVD
PZ, Links / LH

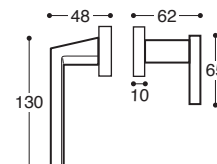

RKAPVC
PZ, Rechts / RH

Kappa/50x50 Metall/Kunststoff Rosetten - Wechselgarnitur

Kappa/Q11 Metall Rosetten - Wechselgarnitur

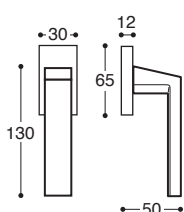

RKAP5I
Ohne Hand / Without hand

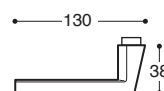

RKAP09
Links / LH

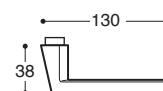

RKAP08
Rechts / RH

Kappa DK Fenstergriffe - Mit Rastung
Window handle - 8 pos. mech.

Kappa
Drückerlochteil - Ohne Rosetten

* auf Anfrage / on demand

matériau / material
Laiton / Brass

standard

Kappa.
design Enrico Cattaneo

finitions standards / standard finishes



00 - Laiton poli
Polished brass



06 - Chrome poli
Polished chrome



08 - Chrome satiné
Satin chrome

finitions trendy / trendy finishes



G3 - Gun metal



15 - Noir mat*
Mat black*



16 - Blanc*
White*

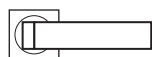

RKAP5S
BDC / Latch

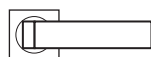

RKAP5P
Cle L / Lock

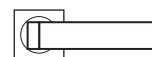

RKAP5Y
Cle I / Cylinder



RKAP5W
Cond/Dec C. 6/7/8 / Privacy

Kappa/Quad Métal rosace - avec ressort, carré 7 mm / Metal rose - springloaded

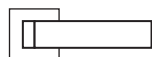

RKAPBS
BDC / Latch

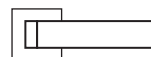

RKAPBP
Cle L / Lock



RKAPBY
Cle I / Cylinder

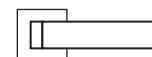

RKAPBW
Cond/Dec C. 6/7/8 / Privacy

Kappa/50x50 Métal et plastique rosace - avec ressort, carré 7 mm / Metal&plastic rose - springloaded

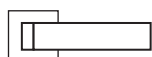

RKAPFS
BDC / Latch

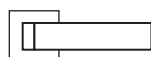

RKAPFP
Cle L / Lock

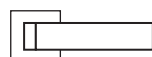

RKAPFY
Cle I / Cylinder

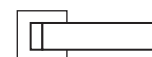

RKAPFW
Cond/Dec C. 6/7/8 / Privacy

Kappa/FLQ Rosette abaissée métal - avec ressort, carré 7 mm / Metal flat rose - springloaded

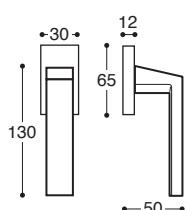

RKAP5I
Sans main / Without hand

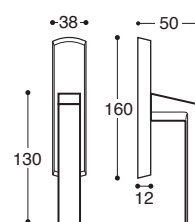

RKAP5K
Sans main / Without hand

Kappa DK Poignée de fenêtre
Mécan. 8 positions / Window handle - 8 pos. mech.

Kappa Martellina Poignée de fenêtre - crémonne
Mécan. exclus / For window - cremon - mec. non included

* sur demande / on demand



Arco.

design Marcello Cutino BCF

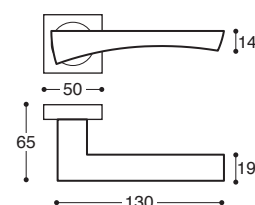

materiale / material
Ottone / Brass

standard

Arco.
design Marcello Cutino BCF

finiture standard / standard finishes



o6 - Cromo lucido
Polished chrome



o8 - Cromo satinato
Satin chrome



BA - Bronzo gr. opaco
Mat satin bronze

finiture trendy / trendy finishes



G3 - Gun metal



15 - Nero opaco*
Mat black*



16 - Bianco*
White*



R00G50
S/bocchetta / Latch

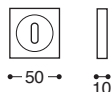

R00G52
Patent / Lock

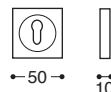

R00G54
Yale / Cylinder

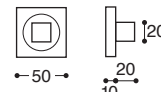

R00G56
WC / Privacy - Q. 6/7/8

Arco/Quad Rosetta metallo - con molla / Metal rose - springloaded



R00GB0
S/bocchetta / Latch

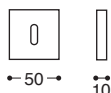

R00GB2
Patent / Lock

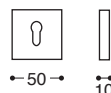

R00GB4
Yale / Cylinder

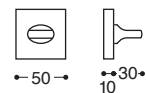

R00GB6
WC / Privacy - Q. 6/7/8

Arco/50x50 Rosetta metallo&plastica - con molla / Metal&plastic rose - springloaded



R00GF0
S/bocchetta / Latch

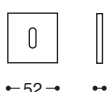

R00GF2
Patent / Lock

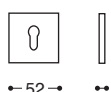

R00GF4
Yale / Cylinder

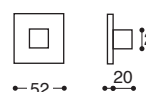

R00GF6
WC / Privacy - Q. 6/7/8

Arco/FLQ Rosetta ribassata metallo - con molla / Metal flat rose - springloaded

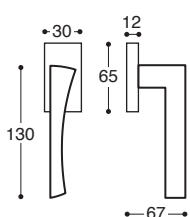

R00G5J
SX / LH

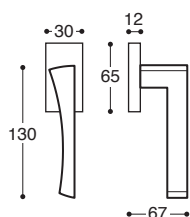

R00G5I
DX / RH

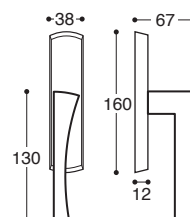

R00G5L
SX / LH

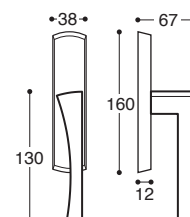

R00G5K
DX / RH

Arco DK - mov. 8 scatti
Window handle - 8 pos. mech.

Arco Martellina Per finestra - cremonese
mov. escluso/ For window - cremon - mec. non included

* a richiesta / on demand

Standardveredelungen / standard finishes



o6 - Chrom
Polished chrome



o8 - Chrom matt
Satin chrome



BA - Matt Satin Bronze
Mat satin bronze

Trendy Veredelungen / trendy finishes



G3 - Gun metal



15 - Matt schwarz*
Mat black*



16 - Weiß*
White*



R00GB0
Ohne Schlüssel / Latch



R00GB3
BB / Lock



R00GB5
PZ / Cylinder



R00GB7
BAD S. 6/7/8 / Privacy

Arco/50x50 Metall/Kunststoff Rosetten DIN 38 mm - Mit Feder / Metal&plastic rose - springloaded



R00GV0
Ohne Schlüssel / Latch



R00GV3
BB / Lock



R00GV5
PZ / Cylinder



R00GV7
BAD S. 6/7/8 / Privacy

Arco/Q11 Metall Rosetten DIN 38 mm - Mit Feder / Metal rose - springloaded

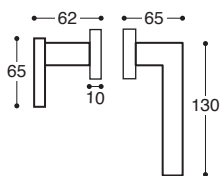

R00GBD
PZ, Links / LH

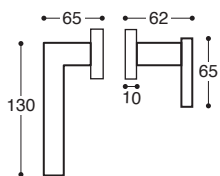

R00GBC
PZ, Rechts / RH

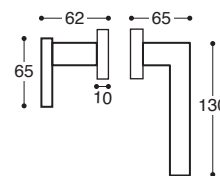

R00GVD
PZ, Links / LH

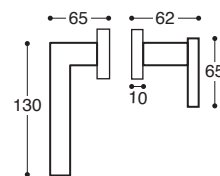

R00GVC
PZ, Rechts / RH

Arco/50x50
Metall/Kunststoff Rosetten - Wechselgarnitur

Arco/Q11
Metall Rosetten - Wechselgarnitur

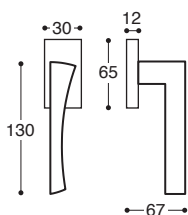

R00G5J
Links / LH

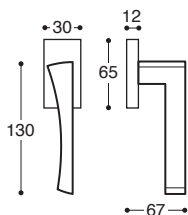

R00G5I
Rechts / RH

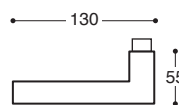

R00G09
Links / LH

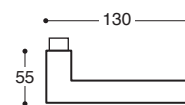

R00G08
Rechts / RH

Arco DK Fenstergriffe - Mit Rastung
Window handle - 8 pos. mech.

Arco
Drückerlochteil - Ohne Rosetten

* auf Anfrage / on demand

matériau / material
Laiton / Brass

standard

Arco.
design Marcello Cutino BCF

finitions standards / standard finishes



o6 - Chrome poli
Polished chrome



o8 - Chrome satiné
Satin chrome



BA - Bronze mat satiné
Mat satin bronze

finitions trendy / trendy finishes



G3 - Gun metal



15 - Noir mat*
Mat black*



16 - Blanc*
White*



R00G5S
BDC / Latch

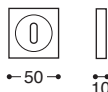

R00G5P
Cle L / Lock

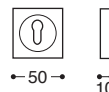

R00G5Y
Cle I / Cylinder

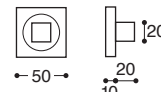

R00G5W
Cond/Dec C. 6/7/8 / Privacy

Arco/Quad Métal rosace - avec ressort, carré 7 mm / **Metal rose** - springloaded

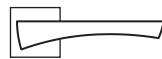

R00GBS
BDC / Latch

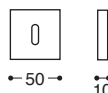

R00GBP
Cle L / Lock

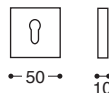

R00GBY
Cle I / Cylinder

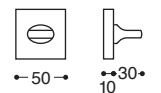

R00GBW
Cond/Dec C. 6/7/8 / Privacy

Arco/50x50 Métal et plastique rosace - avec ressort, carré 7 mm / **Metal&plastic rose** - springloaded



R00GFS
BDC / Latch

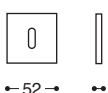

R00GFP
Cle L / Lock

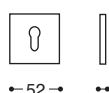

R00GFY
Cle I / Cylinder

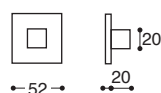

R00GFW
Cond/Dec C. 6/7/8 / Privacy

Arco/FLQ Rosette abaissée métal - avec ressort, carré 7 mm / **Metal flat rose** - springloaded

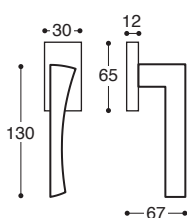

R00G5J
Gauche / LH

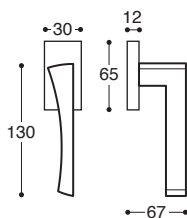

R00G5I
Droite / RH

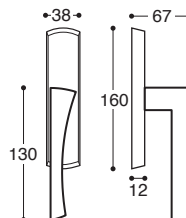

R00G5L
Gauche / LH

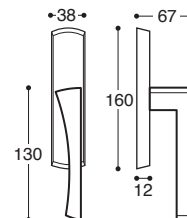

R00G5K
Droite / RH

ARCO DK Poignée de fenêtre
Mécan. 8 positions / Window handle - 8 pos. mech.

ARCO Martellina Poignée de fenêtre - crémonne
Mécan. exclus / For window - cremon - mec. non included

* sur demande / on demand



Bruges.
design Studio RDS

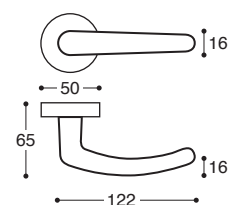

materiale / material
Ottone / Brass



finiture standard / standard finishes



00 - Oro
Polished brass



06 - Cromo lucido
Polished chrome



08 - Cromo satinato
Satin chrome

finiture trendy / trendy finishes



G3 - Gun metal



15 - Nero opaco*
Mat black*



16 - Bianco*
White*



R06760
S/bocchetta / Latch



R06762
Patent / Lock



R06764
Yale / Cylinder



R06766
WC / Privacy - Q. 6/7/8

Bruges/HB14 Rosetta metallo&plastica - con molla / **Metal&plastic rose** - springloaded



R067S0
S/bocchetta / Latch

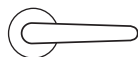

R067S2
Patent / Lock



R067S4
Yale / Cylinder



R067S6
WC / Privacy - Q. 6/7/8

Bruges/52D Rosetta metallo&plastica - con molla / **Metal&plastic rose** - springloaded

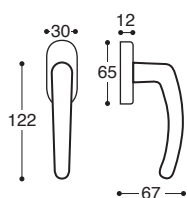

R06761
Senza mano / Without hand

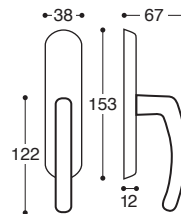

R0676K
Senza mano / Without hand

Bruges DK - mov. 8 scatti
Window handle - 8 pos. mech.

Bruges Martellina Per finestra - cremonese
mov. escluso/ For window - cremon - mec. non included

* a richiesta / on demand

Material / material
Messing / Brass

standard

Standardveredelungen / standard finishes



00 - Messing poliert
Polished brass



06 - Chrom
Polished chrome



08 - Chrom matt
Satin chrome

Trendy Veredelungen / trendy finishes



G3 - Gun metal



15 - Matt schwarz*
Mat black*



16 - Weiß*
White*



R067S0

Ohne Schlüssel / Latch

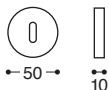

R067S3

BB / Lock

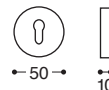

R067S5

PZ / Cylinder

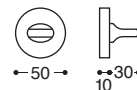

R067S7

BAD S. 6/7/8 / Privacy

Bruges/52D Metall/Kunststoff Rosetten DIN 38 mm - Mit Feder / Metal&plastic rose - springloaded



R06710

Ohne Schlüssel / Latch

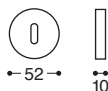

R06713

BB / Lock

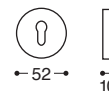

R06715

PZ / Cylinder

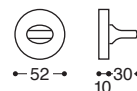

R06717

BAD S. 6/7/8 / Privacy

Bruges/T11 Metall Rosetten DIN 38 mm - Mit Feder / Metal rose - springloaded

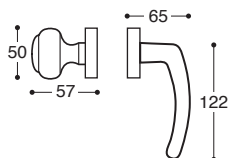

R067SD

PZ, Links / LH

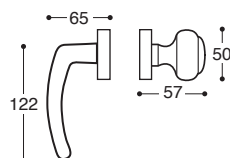

R067SC

PZ, Rechts / RH

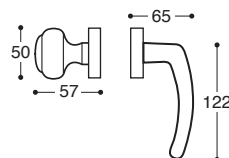

R0671D

PZ, Links / LH

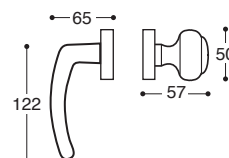

R0671C

PZ, Rechts / RH

Bruges/52D Metall/Kunststoff Rosetten - Wechselgarnitur

Bruges/T11 Metall Rosetten - Wechselgarnitur

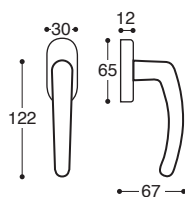

R0676I

Ohne Hand / Without hand

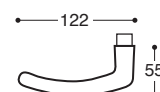

R06709

Links / LH

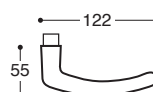

R06708

Rechts / RH

Bruges DK Fenstergriffe - Mit Rastung
Window handle - 8 pos. mech.

Bruges
Drückerlochteil - Ohne Rosetten

* auf Anfrage / on demand

matériau / material
Laiton / Brass

standard

finitions standards / standard finishes



00 - Laiton poli
Polished brass



06 - Chrome poli
Polished chrome



08 - Chrome satiné
Satin chrome

finitions trendy / trendy finishes



G3 - Gun metal



15 - Noir mat*
Mat black*



16 - Blanc*
White*



R0676S
BDC / Latch

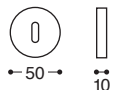

R0676P
Cle L / Lock

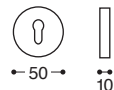

R0676Y
Cle I / Cylinder

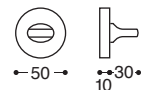

R0676W
Cond/Dec C. 6/7/8 / Privacy

Bruges/HB14 Métal et plastique rosace - avec ressort, carré 7 mm
Metal&plastic rose - springloaded



R067SS
BDC / Latch

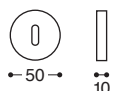

R067S2P
Cle L / Lock

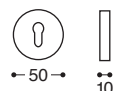

R067SY
Cle I / Cylinder

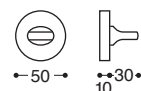

R067SW
Cond/Dec C. 6/7/8 / Privacy

Bruges/52D Métal et plastique rosace - avec ressort, carré 7 mm / Metal&plastic rose - springloaded

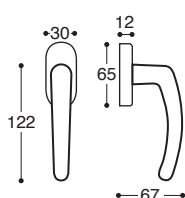

R0676I
Sans main / Without hand

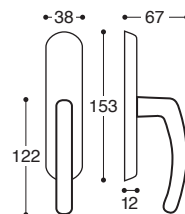

R0676K
Sans main / Without hand

Bruges DK Poignée de fenetre
Mécan. 8 positions / Window handle - 8 pos. mech.

Bruges Martellina Poignée de fenetre - crémone
Mécan. exclus / For window - cremone - mec. non includ.

* sur demande / on demand



Compatta.

design Ivo Pellegrini

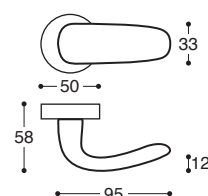

materiale / material
Ottone / Brass

standard

finiture standard / standard finishes



00 - Oro
Polished brass



06 - Cromo lucido
Polished chrome



08 - Cromo satinato
Satin chrome

finiture trendy / trendy finishes



G3 - Gun metal



15 - Nero opaco*
Mat black*



16 - Bianco*
White*



R07560
S/bocchetta / Latch

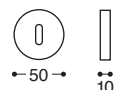

R07562
Patent / Lock

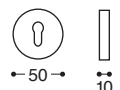

R07564
Yale / Cylinder

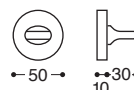

R07566
WC / Privacy - Q. 6/7/8

Compatta/HB14 Rosetta metallo&plastica - con molla / Metal&plastic rose - springloaded



R075S0
S/bocchetta / Latch

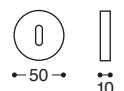

R075S2
Patent / Lock

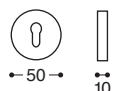

R075S4
Yale / Cylinder



R075S6
WC / Privacy - Q. 6/7/8

Compatta/52D Rosetta metallo&plastica - con molla / Metal&plastic rose - springloaded

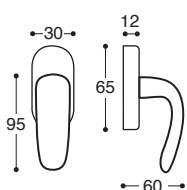

R07561
Senza mano / Without hand

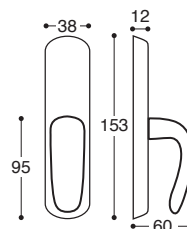

R0756K

Compatta DK - mov. 8 scatti
Window handle - 8 pos. mech.

Compatta Martellina Per finestra - cremonese
mov. escluso/ For window - cremon - mec. non included

* a richiesta / on demand

Material / material
Messing / Brass

standard

Standardveredelungen / standard finishes



00 - Messing poliert
Polished brass



06 - Chrom
Polished chrome



08 - Chrom matt
Satin chrome

Trendy Veredelungen / trendy finishes



G3 - Gun metal



15 - Matt schwarz*
Mat black*



16 - Weiß*
White*



R075S0

Ohne Schlüssel / Latch

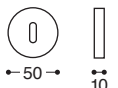

R075S3

BB / Lock

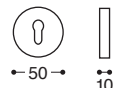

R075S5

PZ / Cylinder

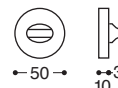

R075S7

BAD S. 6/7/8 / Privacy

Compatta/52D Metall/Kunststoff Rosetten DIN 38 mm - Mit Feder / **Metal&plastic rose** - springloaded



R07510

Ohne Schlüssel / Latch

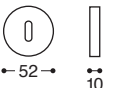

R07513

BB / Lock

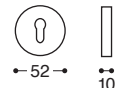

R07515

PZ / Cylinder

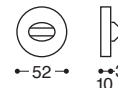

R07517

BAD S. 6/7/8 / Privacy

Compatta/T11 Metall Rosetten DIN 38 mm - Mit Feder / **Metal rose** - springloaded

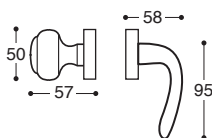

R075SD

PZ, Links / LH

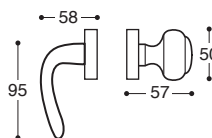

R075SC

PZ, Rechts / RH

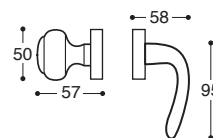

R0751D

PZ, Links / LH

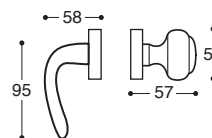

R0751C

PZ, Rechts / RH

Compatta/52D
Metall/Kunststoff Rosetten - Wechselgarnitur

Compatta/T11
Metall Rosetten - Wechselgarnitur

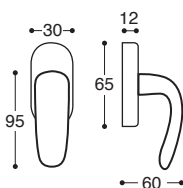

R0756I

Ohne Hand / Without hand

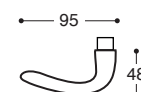

R07509

Links / LH

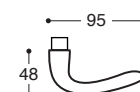

R07508

Rechts / RH

Compatta DK Fenstergriffe
Mit Rastung / Window handle - 8 pos. mech.

Compatta
Drückerlochteil - Ohne Rosetten

* a richiesta / on demand

matériau / material
Laiton / Brass

standard

finitions standards / standard finishes



00 - Laiton poli
Polished brass



06 - Chrome poli
Polished chrome



08 - Chrome satiné
Satin chrome

finitions trendy / trendy finishes



G3 - Gun metal



15 - Noir mat*
Mat black*



16 - Blanc*
White*



R0756S
BDC / Latch



R0756P
Cle L / Lock



R0756Y
Cle I / Cylinder



R0756W
Cond/Dec C. 6/7/8 / Privacy

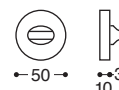
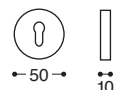
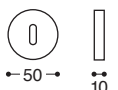

Compatta/HB14 Métal et plastique rosace - avec ressort, carré 7 mm
Metal&plastic rose - springloaded



R075SS
BDC / Latch



R075SP
Cle L / Lock



R075SY
Cle I / Cylinder



R075SW
Cond/Dec C. 6/7/8 / Privacy

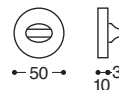
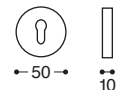
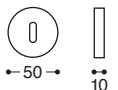

Compatta/52D Métal et plastique rosace - avec ressort, carré 7 mm
Metal&plastic rose - springloaded

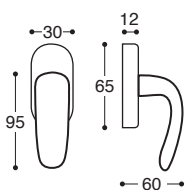

R0756I
Sans main / Without hand

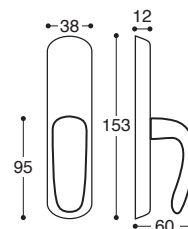

R0756K

Compatta DK Poignée de fenetre
Mécan. 8 positions / Window handle - 8 pos. mech.

Compatta Martellina Poignée de fenetre - crémona
Mécan. exclus / For window - cremon - mec. non included

* sur demande / on demand



Denver.

design Elias Seguí

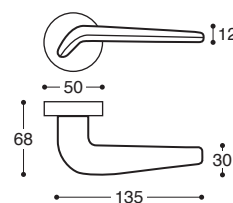

materiale / material
Ottone / Brass

standard

Denver.
design Elias Segui

finiture standard / standard finishes



o0 - Oro
Polished brass



o6 - Cromo lucido
Polished chrome



o8 - Cromo satinato
Satin chrome



R07660
S/bocchetta / Latch

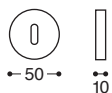

R07662
Patent / Lock

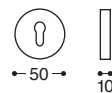

R07664
Yale / Cylinder

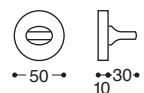

R07666
WC / Privacy - Q. 6/7/8

Denver/HB14 Rosetta metallo&plastica - con molla / Metal&plastic rose - springloaded



R076S0
S/bocchetta / Latch

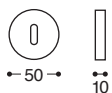

R076S2
Patent / Lock

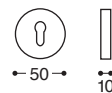

R076S4
Yale / Cylinder

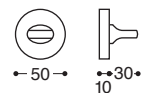

R076S6
WC / Privacy - Q. 6/7/8

Denver/52D Rosetta metallo&plastica - con molla / Metal&plastic rose - springloaded

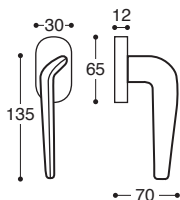

R0766J
SX / LH

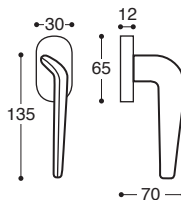

R0766I
DX / RH

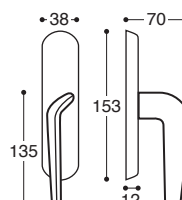

R0766L
SX / LH

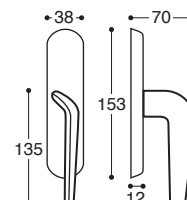

R0766K
DX / RH

Denver DK - mov. 8 scatti
Window handle - 8 pos. mech.

Denver Martellina Per finestra - cremonese
mov. escluso / For window - cremon - mec. non included

Material / material
Messing / Brass

standard

Standardveredelungen / standard finishes



o0 - Messing poliert
Polished brass



o6 - Chrom
Polished chrome



o8 - Chrom matt
Satin chrome



R076S0

Ohne Schlüssel / Latch



R076S3

BB / Lock



R076S5

PZ / Cylinder



R076S7

BAD S. 6/7/8 / Privacy

Denver/52D Metall/Kunststoff Rosetten DIN 38 mm - Mit Feder / Metal&plastic rose - springloaded



R07610

Ohne Schlüssel / Latch



R07613

BB / Lock



R07615

PZ / Cylinder



R07617

BAD S. 6/7/8 / Privacy

Denver/T11 Metall Rosetten DIN 38 mm - Mit Feder / Metal rose - springloaded

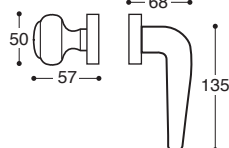

R076SD

PZ, Links / LH

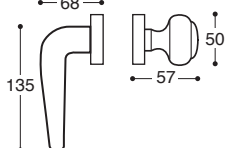

R076SC

PZ, Rechts / RH

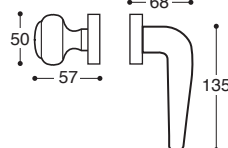

R0761D

PZ, Links / LH

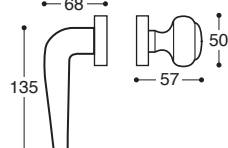

R0761C

PZ, Rechts / RH

Denver/52D Metall/Kunststoff Rosetten - Wechselgarnitur

Denver/T11 Metall Rosetten - Wechselgarnitur

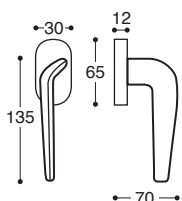

R0766J

Links / LH

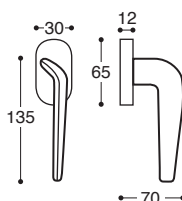

R0766I

Rechts / RH

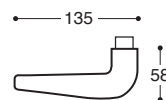

R07609

Links / LH

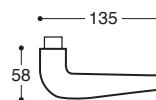

R07608

Rechts / RH

Denver DK Fenstergriffe - Mit Rastung
Window handle - 8 pos. mech.

Denver
Drückerlochteil - Ohne Rosetten

matériau / material
Laiton / Brass

standard

Denver.
design Elias Segui

finitions standards / standard finishes



oo - Laiton poli
Polished brass



o6 - Chrome poli
Polished chrome



o8 - Chrome satiné
Satin chrome



R0766S
BDC / Latch



R0766P
Cle L / Lock



R0766Y
Cle I / Cylinder



R0766W
Cond/Dec C. 6/7/8 / Privacy

Denver/HB14 Métal et plastique rosace - avec ressort, carré 7 mm
Metal&plastic rose - springloaded



R0766SS
BDC / Latch



R0766SP
Cle L / Lock



R0766SY
Cle I / Cylinder



R0766SW
Cond/Dec C. 6/7/8 / Privacy

Denver/52D Métal et plastique rosace - avec ressort, carré 7 mm / Metal&plastic rose - springloaded

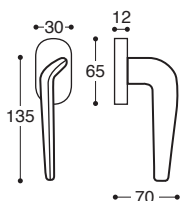

R0766J
Gauche / LH

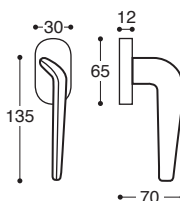

R0766I
Droite / RH

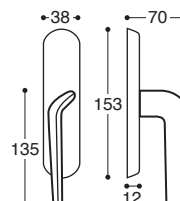

R0766L
Gauche / LH

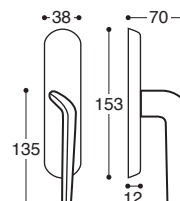

R0766K
Droite / RH

Denver DK Poignée de fenetre
Mécan. 8 positions / Window handle - 8 pos. mech.

Denver Martellina Poignée de fenetre - crémone
Mécan. exclus / For window - cremon - mec. non include



Elba.

design Giovanni Amalfitano

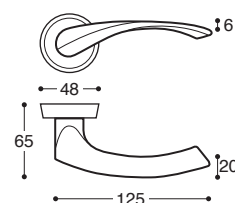

materiale / material
Ottone / Brass

standard

Elba.
design Giovanni Amalfitano

finiture standard / standard finishes



o0 - Oro
Polished brass



o6 - Cromo lucido
Polished chrome



o8 - Cromo satinato
Satin chrome



R05740
S/bocchetta / Latch



R05742
Patent / Lock



R05744
Yale / Cylinder



R05746
WC / Privacy - Q. 6/7/8

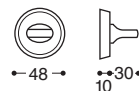
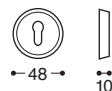
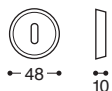

Elba/HB11 Rosetta metallo&plastica - con molla / **Metal&plastic rose** - springloaded



R057S0
S/bocchetta / Latch



R057S2
Patent / Lock



R057S4
Yale / Cylinder



R057S6
WC / Privacy - Q. 6/7/8

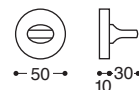
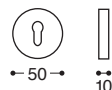
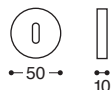

Elba/52D Rosetta metallo&plastica - con molla / **Metal&plastic rose** - springloaded

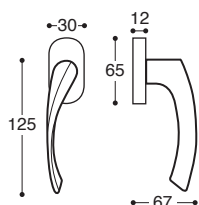

R0574J
SX / LH

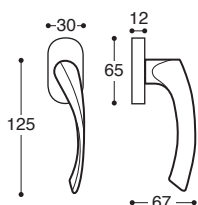

R0574I
DX / RH

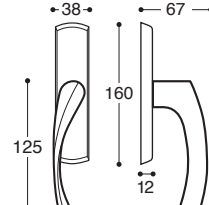

R0574L
SX / LH

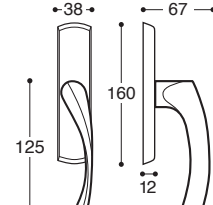

R0574K
DX / RH

Elba DK - mov. 8 scatti
Window handle - 8 pos. mech.

Elba Martellina Per finestra - cremonese
mov. escluso/ For window - cremon - mec. non included

Material / material
 Messing / Brass

standard

Standardveredelungen / standard finishes



o0 - Messing poliert
 Polished brass

o6 - Chrom
 Polished chrome

o8 - Chrom matt
 Satin chrome

R057S0

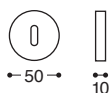
Ohne Schlüssel / Latch

R057S3

BB / Lock

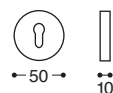
R057S5

PZ / Cylinder

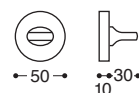

R057S7

BAD S. 6/7/8 / Privacy

Elba/52D Metall/Kunststoff Rosetten DIN 38 mm - Mit Feder / Metal&plastic rose - springloaded

R05710

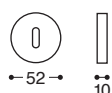
Ohne Schlüssel / Latch

R05713

BB / Lock

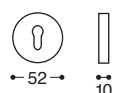
R05715

PZ / Cylinder

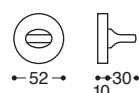
R05717

BAD S. 6/7/8 / Privacy

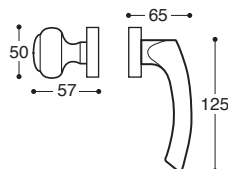
Elba/T11 Metall Rosetten DIN 38 mm - Mit Feder / Metal rose - springloaded

R057SD

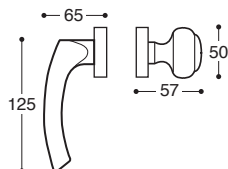
PZ, Links / LH

R057SC

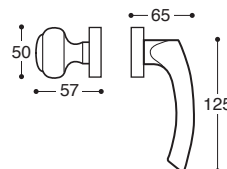
PZ, Rechts / RH

R0571D

PZ, Links / LH

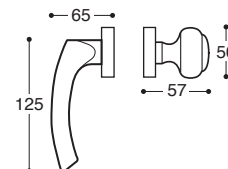
R0571C

PZ, Rechts / RH

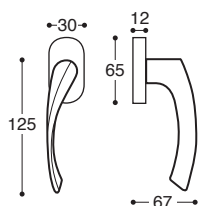
Elba/52D Metall/Kunststoff Rosetten - Wechselgarnitur
Elba/T11 Metall Rosetten - Wechselgarnitur

R0574J

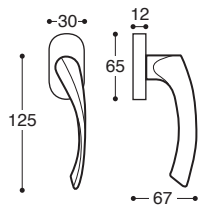
Links / LH

R0574I

Rechts / RH

R05709

Links / LH

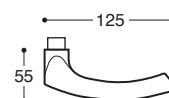
R05708

Rechts / RH

Elba DK Fenstergriffe - Mit Rastung
 Window handle - 8 pos. mech.

Elba
 Drückerlochteil - Ohne Rosetten

matériau / material
 Laiton / Brass

standard

finitions standards / standard finishes



o0 - Laiton poli
 Polished brass

o6 - Chrome poli
 Polished chrome

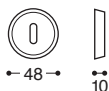
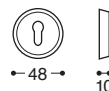
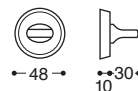
o8 - Chrome satiné
 Satin chrome

R0574S
 BDC / Latch

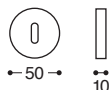
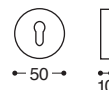
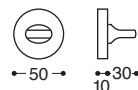
R0574P
 Cle L / Lock

R0574Y
 Cle I / Cylinder

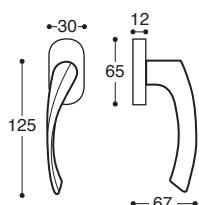
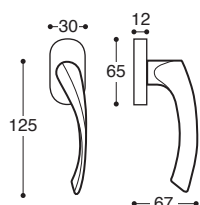
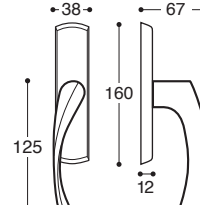
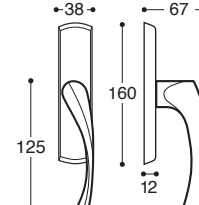
R0574W
 Cond/Dec C. 6/7/8 / Privacy

Elba/HB11 Métal et plastique rosace - avec ressort, carré 7 mm / Metal&plastic rose - springloaded

R057SS
 BDC / Latch

R057SP
 Cle L / Lock

R057SY
 Cle I / Cylinder

R057SW
 Cond/Dec C. 6/7/8 / Privacy

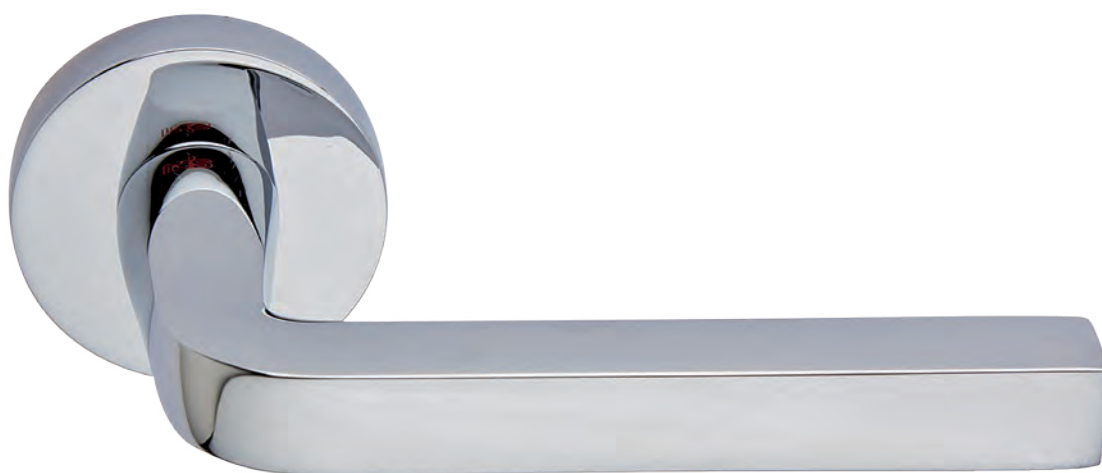
Elba/52D Métal et plastique rosace - avec ressort, carré 7 mm / Metal&plastic rose - springloaded

R0574J
 Gauche / LH

R0574I
 Droite / RH

R0574L
 SX / LH

R0574K
 DX / RH

Elba DK Poignée de fenetre
 Mécan. 8 positions / Window handle - 8 pos. mech.

Elba Martellina Poignée de fenetre - crémona
 Mécan. exclus / For window - cremon - mec. non included



Milano.

design Ivo Pellegrini

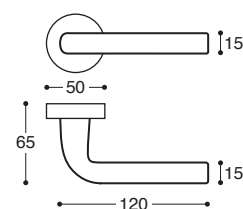

materiale / material
Ottone / Brass

standard

finiture standard / standard finishes



00 - Oro
Polished brass



06 - Cromo lucido
Polished chrome



08 - Cromo satinato
Satin chrome

finiture trendy / trendy finishes



G3 - Gun metal



15 - Nero opaco*
Mat black*



16 - Bianco*
White*

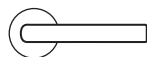

R05360
S/bocchetta / Latch

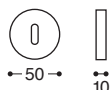
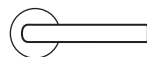

R05362
Patent / Lock

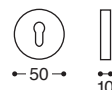

R05364
Yale / Cylinder

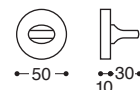

R05366
WC / Privacy - Q. 6/7/8

Milano/HB14 Rosetta metallo&plastica - con molla / Metal&plastic rose - springloaded

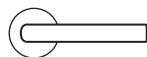

R053S0
S/bocchetta / Latch

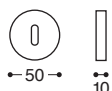
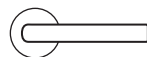

R053S2
Patent / Lock

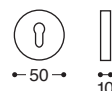

R053S4
Yale / Cylinder

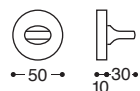
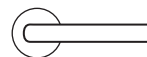

R053S6
WC / Privacy - Q. 6/7/8

Milano/52D Rosetta metallo&plastica - con molla / Metal&plastic rose - springloaded

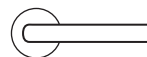

R053P0
S/bocchetta / Latch

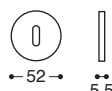
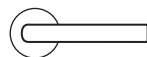

R053P2
Patent / Lock

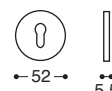

R053P4
Yale / Cylinder

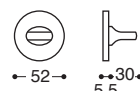

R053P6
WC / Privacy - Q. 6/7/8

Milano/FLT Rosetta ribassata metallo - con molla / Metal flat rose - springloaded

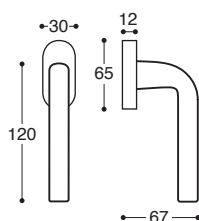

R05361
Senza mano / Without hand

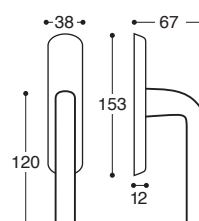

R0536K

Milano DK - mov. 8 scatti
Window handle - 8 pos. mech.

Milano Martellina Per finestra - cremonese
mov. escluso/ For window - cremon - mec. non included

* a richiesta / on demand

Material / material
Messing / Brass

standard

Standardveredelungen / standard finishes



o0 - Messing poliert
Polished brass



o6 - Chrom
Polished chrome



o8 - Chrom matt
Satin chrome

Trendy Veredelungen / trendy finishes



G3 - Gun metal



15 - Matt schwarz*
Mat black*



16 - Weiß*
White*

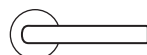

R053S0
Ohne Schlüssel / Latch

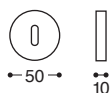
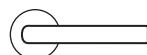

R053S3
BB / Lock

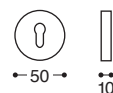

R053S5
PZ / Cylinder

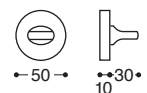

R053S7
BAD S. 6/7/8 / Privacy

Milano/52D Metall/Kunststoff Rosetten DIN 38 mm - Mit Feder / Metal&plastic rose - springloaded

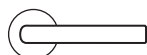

R05310
Ohne Schlüssel / Latch

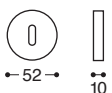

R05313
BB / Lock

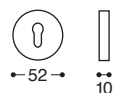

R05315
PZ / Cylinder

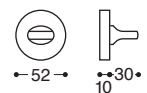
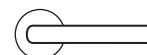

R05317
BAD S. 6/7/8 / Privacy

Milano/T11 Metall Rosetten DIN 38 mm - Mit Feder / Metal rose - springloaded

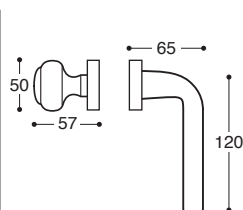

R053SD
PZ, Links / LH

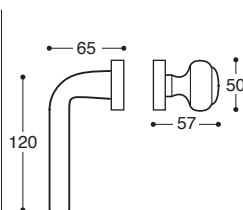

R053SC
PZ, Rechts / RH

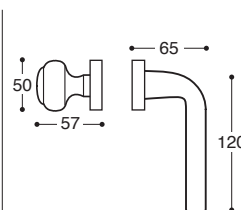

R0531D
PZ, Links / LH

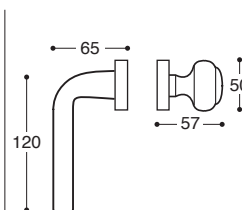

R0531C
PZ, Rechts / RH

Milano/52D
Metall/Kunststoff Rosetten - Wechselgarnitur

Milano/T11
Metall Rosetten - Wechselgarnitur

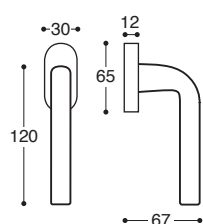

R05361
Ohne Hand / Without hand

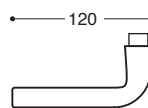

R05309
Links / LH

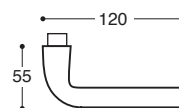

R05308
Rechts / RH

Milano DK Fenstergriffe - Mit Rastung
Window handle - 8 pos. mech.

Milano
Drückerlochteil - Ohne Rosetten

* auf Anfrage / on demand

matériau / material
Laiton / Brass

standard

finitions standards / standard finishes



00 - Laiton poli
Polished brass



06 - Chrome poli
Polished chrome



08 - Chrome satiné
Satin chrome

finitions trendy / trendy finishes



G3 - Gun metal



15 - Noir mat*
Mat black*



16 - Blanc*
White*

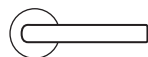

R0536S
BDC / Latch

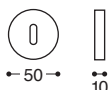
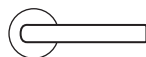

R05362P
Cle L / Lock

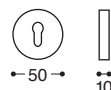

R0536Y
Cle I / Cylinder

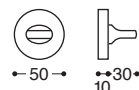

R0536W
Cond/Dec C. 6/7/8 / Privacy

Milano/HB14 Métal et plastique rosace - avec ressort, carré 7 mm
Metal&plastic rose - springloaded

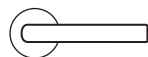

R053SS
BDC / Latch

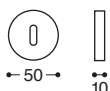
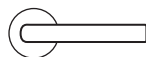

R053SP
Cle L / Lock

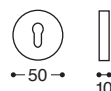

R053SY
Cle I / Cylinder

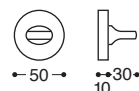

R053SW
Cond/Dec C. 6/7/8 / Privacy

Milano/52D Métal et plastique rosace - avec ressort, carré 7 mm / Metal&plastic rose - springloaded

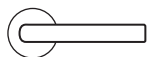

R053PS
BDC / Latch

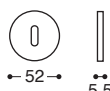
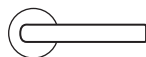

R053PP
Cle L / Lock

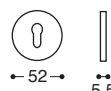

R053PY
Cle I / Cylinder

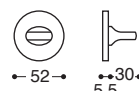

R053PW
Cond/Dec C. 6/7/8 / Privacy

Milano/FLT Rosette abaissée métal - avec ressort, carré 7 mm / Metal flat rose - springloaded

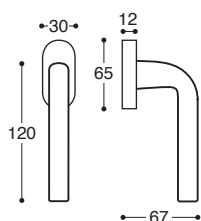

R0536I
Sans main / Without hand

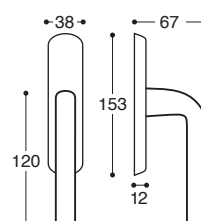

R0536K

Milano DK Poignée de fenetre
Mécan. 8 positions / Window handle - 8 pos. mech.

Milano Martellina Poignée de fenetre - crémone
Mécan. exclus / For window - cremone - mec. non included

* sur demande / on demand



Milano Quadra.

design Ivo Pellegrini

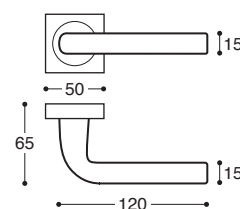

materiale / material
Ottone / Brass

standard

Milano Quadra.
design Ivo Pellegrini

finiture standard / standard finishes



00 - Oro
Polished brass



06 - Cromo lucido
Polished chrome



08 - Cromo satinato
Satin chrome

finiture trendy / trendy finishes



G3 - Gun metal



15 - Nero opaco*
Mat black*



16 - Bianco*
White*

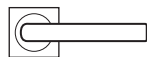

R05350
S/bocchetta / Latch

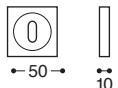
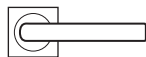

R05352
Patent / Lock

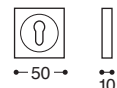
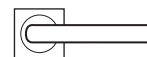

R05354
Yale / Cylinder

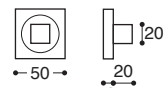
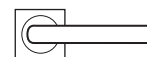

R05356
WC / Privacy - Q. 6/7/8

Milano/Quad Rosetta metallo - con molla / Metal rose - springloaded

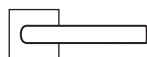

R053B0
S/bocchetta / Latch

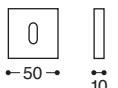

R053B2
Patent / Lock

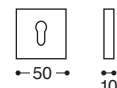
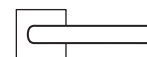

R053B4
Yale / Cylinder

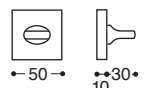

R053B6
WC / Privacy - Q. 6/7/8

Milano/50x50 Rosetta metallo&plastica - con molla / Metal&plastic rose - springloaded

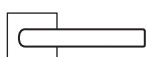

R053F0
S/bocchetta / Latch

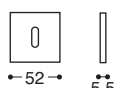
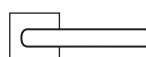

R053F2
Patent / Lock

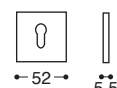
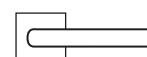

R053F4
Yale / Cylinder

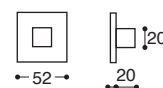
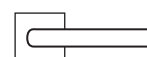

R053F6
WC / Privacy - Q. 6/7/8

Milano/FLQ Rosetta ribassata metallo - con molla / Metal flat rose - springloaded

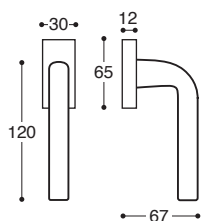

R05351
Senza mano / Without hand

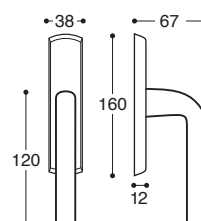

R0536L

Milano DK - mov. 8 scatti
Window handle - 8 pos. mech.

Milano Martellina Per finestra - cremonese
mov. escluso/ For window - cremon - mec. non included

* a richiesta / on demand

Material / material
 Messing / Brass

standard

Standardveredelungen / standard finishes

00 - Messing poliert
 Polished brass

06 - Chrom
 Polished chrome

08 - Chrom matt
 Satin chrome

Trendy Veredelungen / trendy finishes

G3 - Gun metal

15 - Matt schwarz*
 Mat black*

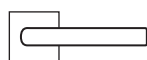
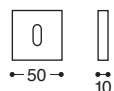
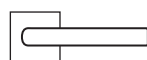
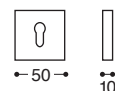
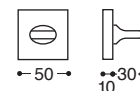
16 - Weiß*
 White*

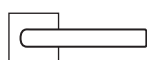
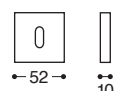
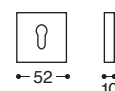
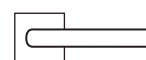
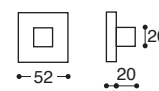
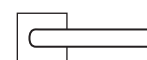
R053B0
 Ohne Schlüssel / Latch

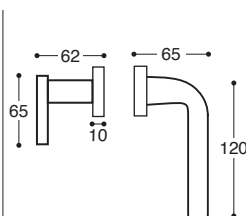
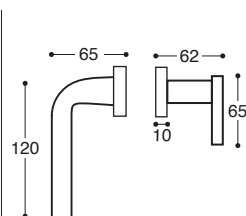
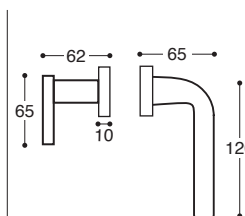
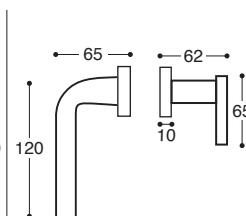
R053B3
 BB / Lock

R053B5
 PZ / Cylinder

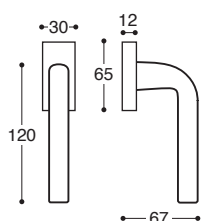
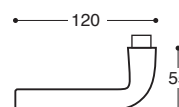
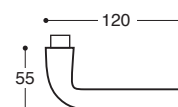
R053B7
 BAD S. 6/7/8 / Privacy

Milano/50x50 Metall/Kunststoff Rosetten DIN 38 mm - Mit Feder / **Metal&plastic rose** - springloaded

R053V0
 Ohne Schlüssel / Latch

R053V3
 BB / Lock

R053V5
 PZ / Cylinder

R053V7
 BAD S. 6/7/8 / Privacy

Milano/Q11 Metall Rosetten DIN 38 mm - Mit Feder / **Metal rose** - springloaded

R053BD
 PZ, Links / LH

R053BC
 PZ, Rechts / RH

R053VD
 PZ, Links / LH

R053VC
 PZ, Rechts / RH

Milano/50x50
 Metall/Kunststoff Rosetten - Wechselgarnitur

Milano/Q11
 Metall Rosetten - Wechselgarnitur

R05371
 Ohne Hand / Without hand

R05309
 Links / LH

R05308
 Rechts / RH

Milano DK Fenstergriffe - Mit Rastung
 Window handle - 8 pos. mech.

Milano
 Drückerlochteil - Ohne Rosetten

* auf Anfrage / on demand

matériau / material
Laiton / Brass

standard

Milano Quadra.
design Ivo Pellegrini

finitions standards / standard finishes



00 - Laiton poli
Polished brass



06 - Chrome poli
Polished chrome



08 - Chrome satiné
Satin chrome

finitions trendy / trendy finishes



G3 - Gun metal



15 - Noir mat*
Mat black*



16 - Blanc*
White*

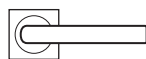

R0535S
BDC / Latch

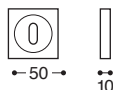
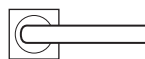

R0535P
Cle L / Lock

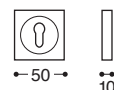
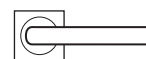

R0535Y
Cle I / Cylinder

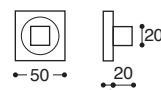
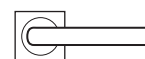

R05356W
Cond/Dec C. 6/7/8 / Privacy

Milano/Quad Métal rosace - avec ressort, carré 7 mm / **Metal rose** - springloaded



R053BS
BDC / Latch

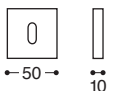
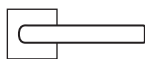

R053BP
Cle L / Lock

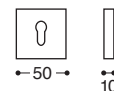
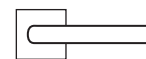

R053BY
Cle I / Cylinder

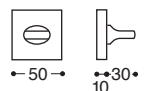

R053BW
Cond/Dec C. 6/7/8 / Privacy

Milano/50x50 Métal et plastique rosace - avec ressort, carré 7 mm
Metal&plastic rose - springloaded

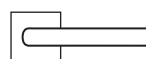

R053FS
BDC / Latch

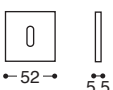
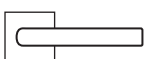

R053FP
Cle L / Lock

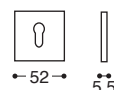

R053FY
Cle I / Cylinder

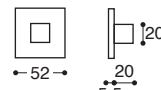

R053FW
Cond/Dec C. 6/7/8 / Privacy

Milano/FLQ Rosette abaissée métal - avec ressort, carré 7 mm / **Metal flat rose** - springloaded

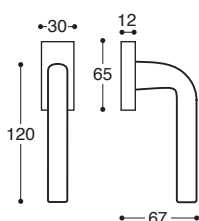

R0535I
Sans main / Without hand

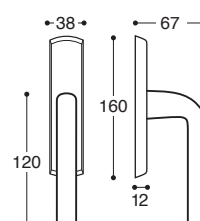

R0536L

Milano DK Poignée de fenêtre
Mécan. 8 positions / Window handle - 8 pos. mech.

Milano Martellina Poignée de fenêtre - crémone
Mécan. exclus / For window - cremone - mec. non included

* sur demande / on demand



Odessa.

design Maurizio Duranti

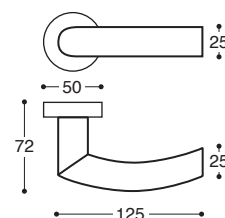

materiale / material
Surlyn

finiture standard / standard finishes



21 - Cromo satinato + bianco
 Satin chrome + white

04 - Cromo satinato + blu
 Satin chrome + blue

05 - Cromo satinato + verde
 Satin chrome + green

63 - Cromo sat. + antracite
 Sat. chrome + anthracite

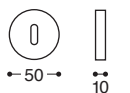
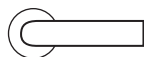
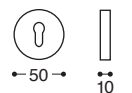
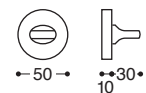
64 - Cromo sat. + arancio
 Satin chrome + orange

R07260
 S/bocchetta / Latch

R07262
 Patent / Lock

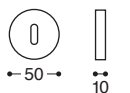
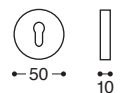
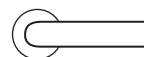
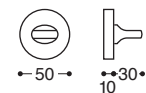
R07264
 Yale / Cylinder

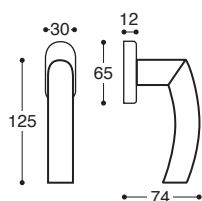
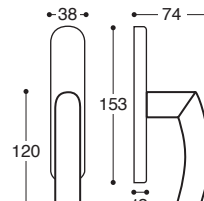
R07266
 WC / Privacy - Q. 6/7/8

Odessa/HB14 Rosetta metallo&plastica - con molla / **Metal&plastic rose** - springloaded

R072S0
 S/bocchetta / Latch

R072S2
 Patent / Lock

R072S4
 Yale / Cylinder

R072S6
 WC / Privacy - Q. 6/7/8

Odessa/52D Rosetta metallo&plastica - con molla / **Metal&plastic rose** - springloaded

R07261
 Senza mano / Without hand

R0726K
Odessa DK - mov. 8 scatti
 Window handle - 8 pos. mech.

Odessa Martellina Per finestra - cremonese
 mov. escluso / For window - cremon - mec. non included

Material / material
 Surlyn

Standardveredelungen / standard finishes

21 - Matt Chrom + Weiß
 Satin chrome + white

04 - Matt Chrom + Blau
 Satin chrome + blue

05 - Matt Chrom + Grün
 Satin chrome + green

63 - Matt Chrom + Anthrazit
 Sat. chrome + anthracite

64 - Matt Chrom + Orange
 Satin chrome + orange

R072S0

Ohne Schlüssel / Latch

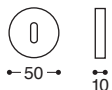
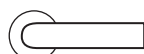
R072S3

BB / Lock

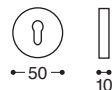
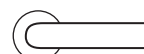
R072S5

PZ / Cylinder

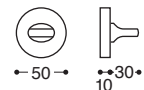
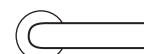
R072S7

BAD S. 6/7/8 / Privacy

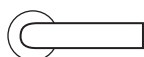
Odessa/52D Metall/Kunststoff Rosetten DIN 38 mm - Mit Feder / Metal&plastic rose - springloaded

R07210

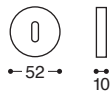
Ohne Schlüssel / Latch

R07213

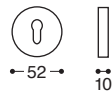
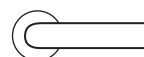
BB / Lock

R07215

PZ / Cylinder

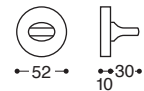
R07217

BAD S. 6/7/8 / Privacy

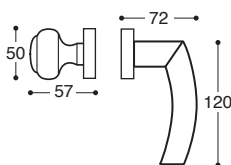
Odessa/T11 Metall Rosetten DIN 38 mm - Mit Feder / Metal rose - springloaded

R072SD

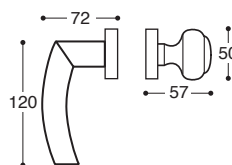
PZ, Links / LH

R072SC

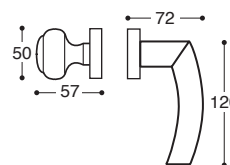
PZ, Rechts / RH

R0721D

PZ, Links / LH

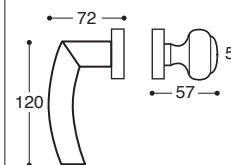
R0721C

PZ, Rechts / RH

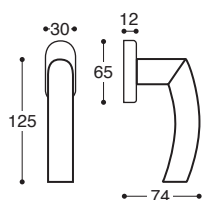
Odessa/52D Metall/Kunststoff Rosetten - Wechselgarnitur
Odessa/T11 Metall Rosetten - Wechselgarnitur

R07261

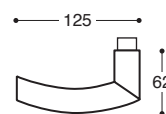
Ohne Hand / Without hand

R07209

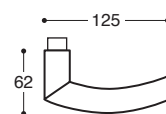
Links / LH

R07208

Rechts / RH

Odessa DK Fenstergriffe - Mit Rastung
 Window handle - 8 pos. mech.

Odessa
 Drückerlochteil - Ohne Rosetten

matériau / material
 Surlyn

standard

finitions standards / standard finishes

21 - Chrome satiné + blanc
 Satin chrome + white

04 - Chrome satiné + bleu
 Satin chrome + blue

05 - Chrome satiné + vert
 Satin chrome + green

63 - Chrome sat. + anthracite
 Sat. chrome + anthracite

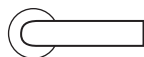
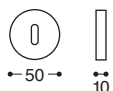
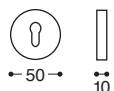
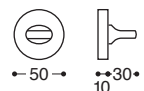
64 - Chrome satiné + orange
 Satin chrome + orange

R0726S
 BDC / Latch

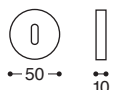
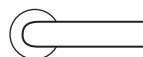
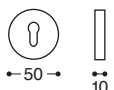
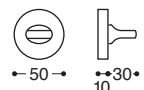
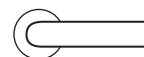
R0726P
 Cle L / Lock

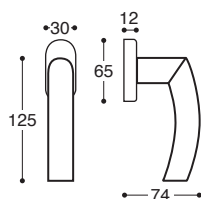
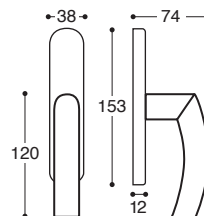
R0726Y
 Cle I / Cylinder

R0726W
 Cond/Dec C. 6/7/8 / Privacy

Odessa/HB14 Métal et plastique rosace - avec ressort, carré 7 mm
 Metal&plastic rose - springloaded

R072SS
 BDC / Latch

R072SP
 Cle L / Lock

R072SY
 Cle I / Cylinder

R072SW
 Cond/Dec C. 6/7/8 / Privacy

Odessa/52D Métal et plastique rosace - avec ressort, carré 7 mm / Metal&plastic rose - springloaded

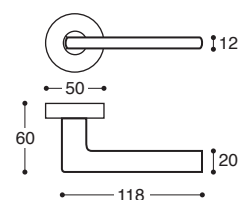
R0726I
 Sans main / Without hand

R0726K
Odessa DK Poignée de fenetre
 Mécan. 8 positions / Window handle - 8 pos. mech.

Odessa Martellina Poignée de fenetre - crémona
 Mécan. exclus / For window - cremon - mec. non included



Verona.
design Studio RDS



materiale / material
Ottone / Brass

standard

finiture standard / standard finishes



o0 - Oro
Polished brass



o6 - Cromo lucido
Polished chrome



o8 - Cromo satinato
Satin chrome

finiture trendy / trendy finishes



G3 - Gun metal



15 - Nero opaco*
Mat black*



16 - Bianco*
White*



R03560
S/bocchetta / Latch

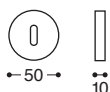

R03562
Patent / Lock

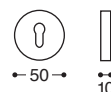

R03564
Yale / Cylinder

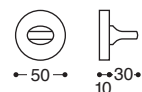

R03566
WC / Privacy - Q. 6/7/8

Verona/HB14 Rosetta metallo&plastica - con molla / Metal&plastic rose - springloaded



R035S0
S/bocchetta / Latch

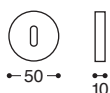

R035S2
Patent / Lock

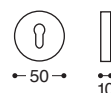

R035S4
Yale / Cylinder

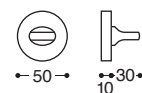

R035S6
WC / Privacy - Q. 6/7/8

Verona/52D Rosetta metallo&plastica - con molla / Metal&plastic rose - springloaded



R035P0
S/bocchetta / Latch

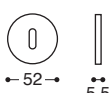

R035P2
Patent / Lock

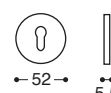

R035P4
Yale / Cylinder



R035P6
WC / Privacy - Q. 6/7/8

Verona/FLT Rosetta ribassata metallo - con molla / Metal flat rose - springloaded

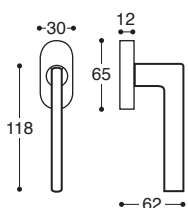

R03561
Senza mano / Without hand

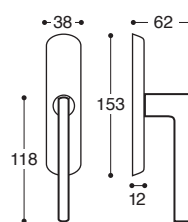

R0356K

Verona DK - mov. 8 scatti
Window handle - 8 pos. mech.

Verona Martellina Per finestra - cremonese
mov. escluso/ For window - cremon - mec. non included

* a richiesta / on demand

Material / material
Messing / Brass

standard

Standardveredelungen / standard finishes



o0 - Messing poliert
Polished brass



o6 - Chrom
Polished chrome



o8 - Chrom matt
Satin chrome

Trendy Veredelungen / trendy finishes



G3 - Gun metal



15 - Matt schwarz*
Mat black*



16 - Weiß*
White*



R035S0

Ohne Schlüssel / Latch

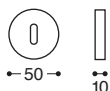

R035S3

BB / Lock

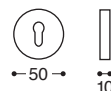

R035S5

PZ / Cylinder

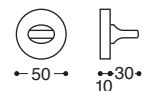

R035S7

BAD S. 6/7/8 / Privacy

Verona/52D Metall/Kunststoff Rosetten DIN 38 mm - Mit Feder / Metal&plastic rose - springloaded



R03510

Ohne Schlüssel / Latch

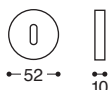

R03513

BB / Lock

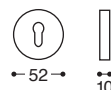

R03515

PZ / Cylinder

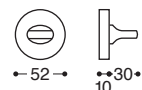

R03517

BAD S. 6/7/8 / Privacy

Verona/T11 Metall Rosetten DIN 38 mm - Mit Feder / Metal rose - springloaded

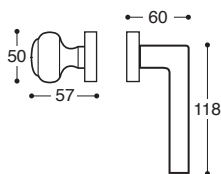

R035SD

PZ, Links / LH

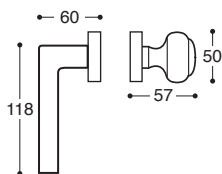

R035SC

PZ, Rechts / RH

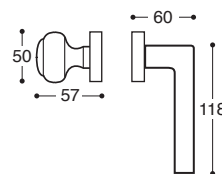

R0351D

PZ, Links / LH

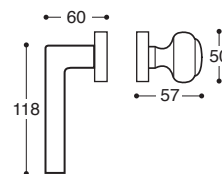

R0351C

PZ, Rechts / RH

Verona/52D Metall/Kunststoff Rosetten - Wechselgarnitur

Verona/T11 Metall Rosetten - Wechselgarnitur

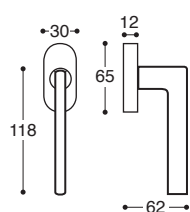

R03561

Ohne Hand / Without hand

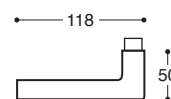

R03509

Links / LH

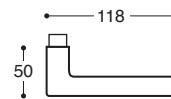

R03508

Rechts / RH

Verona DK Fenstergriffe - Mit Rastung
Window handle - 8 pos. mech.

Verona
Drückerlochteil - Ohne Rosetten

* auf Anfrage / on demand

matériau / material
Laiton / Brass

standard

finitions standards / standard finishes



00 - Laiton poli
Polished brass



06 - Chrome poli
Polished chrome



08 - Chrome satiné
Satin chrome

finitions trendy / trendy finishes



G3 - Gun metal



15 - Noir mat*
Mat black*



16 - Blanc*
White*



R0356S
BDC / Latch

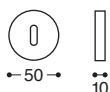

R0356P
Cle L / Lock

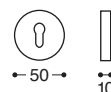

R0356Y
Cle I / Cylinder

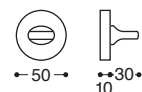

R0356W
Cond/Dec C. 6/7/8 / Privacy

Verona/HB14 Métal et plastique rosace - avec ressort, carré 7 mm
Metal&plastic rose - springloaded



R035SS
BDC / Latch

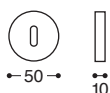

R035SP
Cle L / Lock

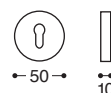

R035SY
Cle I / Cylinder

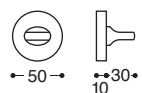

R035SW
Cond/Dec C. 6/7/8 / Privacy

Verona/52D Métal et plastique rosace - avec ressort, carré 7 mm / Metal&plastic rose - springloaded



R035PS
BDC / Latch

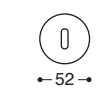

R035PP
Cle L / Lock

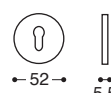

R035PY
Cle I / Cylinder

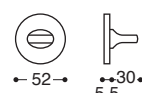

R035PW
Cond/Dec C. 6/7/8 / Privacy

Verona/FLT Rosette abaissée métal - avec ressort, carré 7 mm / Metal flat rose - springloaded

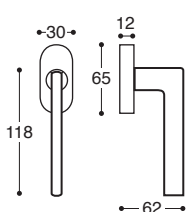

R0356I

Sans main / Without hand

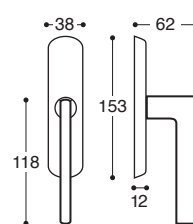

R0356K

Verona DK Poignée de fenetre
Mécan. 8 positions / Window handle - 8 pos. mech.

Verona Martellina Poignée de fenetre - crémona
Mécan. exclus / For window - cremon - mec. non included

* sur demande / on demand



Verona Quadra.

design Studio RDS

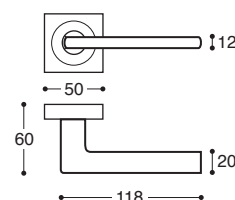

materiale / material
Ottone / Brass

standard

Verona Quadra.
design Studio RDS

finiture standard / standard finishes



00 - Oro
Polished brass



06 - Cromo lucido
Polished chrome



08 - Cromo satinato
Satin chrome

finiture trendy / trendy finishes



G3 - Gun metal



15 - Nero opaco*
Mat black*



16 - Bianco*
White*



R03550
S/bocchetta / Latch

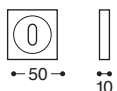
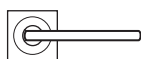

R03552
Patent / Lock

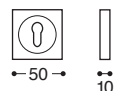
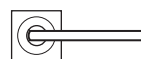

R03554
Yale / Cylinder

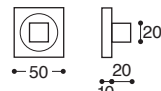

R03556
WC / Privacy - Q. 6/7/8

Verona/Quad Rosetta metallo - con molla / **Metal rose** - springloaded

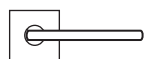

R035B0
S/bocchetta / Latch

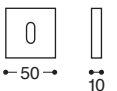

R035B2
Patent / Lock

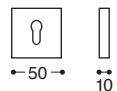
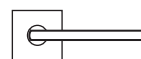

R035B4
Yale / Cylinder

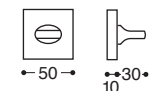

R035B6
WC / Privacy - Q. 6/7/8

Verona/50x50 Rosetta metallo&plastica - con molla / **Metal&plastic rose** - springloaded

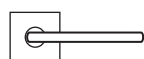

R035F0
S/bocchetta / Latch

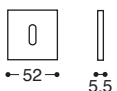
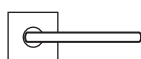

R035F2
Patent / Lock

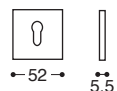

R035F4
Yale / Cylinder

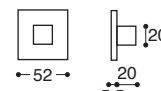
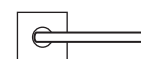

R035F6
WC / Privacy - Q. 6/7/8

Verona/FLQ Rosetta ribassata metallo - con molla / **Metal flat rose** - springloaded

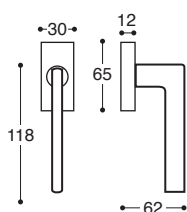

R03551
Senza mano / Without hand

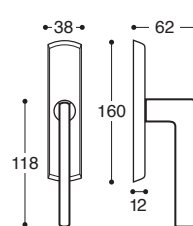

R0355K

Verona DK - mov. 8 scatti
Window handle - 8 pos. mech.

Verona Martellina Per finestra - cremonese
mov. escluso/ For window - cremon - mec. non included

* a richiesta / on demand

Material / material
Messing / Brass

standard

Verona Quadra.
design Studio RDS

Standardveredelungen / standard finishes



00 - Messing poliert
Polished brass



06 - Chrom
Polished chrome



08 - Chrom matt
Satin chrome

Trendy Veredelungen / trendy finishes



G3 - Gun metal



15 - Matt schwarz*
Mat black*



16 - Weiß*
White*



R035B0
Ohne Schlüssel / Latch

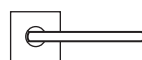

R035B3
BB / Lock

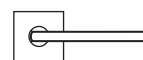

R035B5
PZ / Cylinder

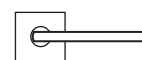

R035B7
BAD S. 6/7/8 / Privacy

Verona/50x50 Metall/Kunststoff Rosetten DIN 38 mm - Mit Feder / Metal&plastic rose - springloaded

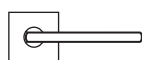

R035V0
Ohne Schlüssel / Latch

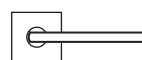

R035V3
BB / Lock



R035V5
PZ / Cylinder

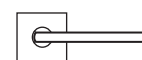

R035V7
BAD S. 6/7/8 / Privacy

Verona/Q11 Metall Rosetten DIN 38 mm - Mit Feder / Metal rose - springloaded

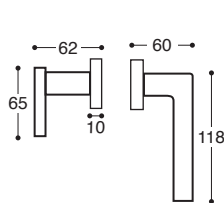

R035BD
PZ, Links / LH

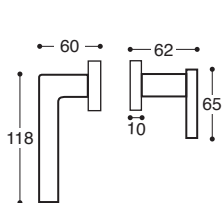

R035BC
PZ, Rechts / RH

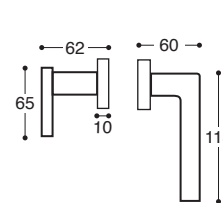

R035VD
PZ, Links / LH

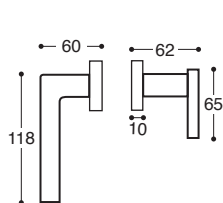

R035VC
PZ, Rechts / RH

Verona/50x50
Metall/Kunststoff Rosetten - Wechselgarnitur

Verona/G11
Metall Rosetten - Wechselgarnitur

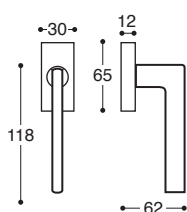

R03571
Ohne Hand / Without hand

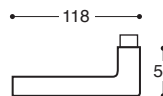

R03509
Links / LH

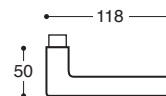

R03508
Rechts / RH

Verona DK Fenstergriffe - Mit Rastung
Window handle - 8 pos. mech.

Verona
Drückerlochteil - Ohne Rosetten

* auf Anfrage / on demand

matériau / material
Laiton / Brass

standard

Verona Quadra.
design Studio RDS

finitions standards / standard finishes



00 - Laiton poli
Polished brass



06 - Chrome poli
Polished chrome



08 - Chrome satiné
Satin chrome

finitions trendy / trendy finishes



G3 - Gun metal



15 - Noir mat*
Mat black*



16 - Blanc*
White*



R0355S
BDC / Latch

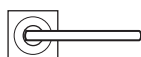

R0355P
Cle L / Lock

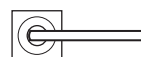

R0355Y
Cle I / Cylinder



R0355W
Cond/Dec C. 6/7/8 / Privacy

Verona/Quad Métal rosace - avec ressort, carré 7 mm / **Metal rose** - springloaded



R035BS
BDC / Latch



R035BP
Cle L / Lock

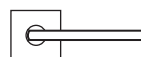

R035BY
Cle I / Cylinder



R035BW
Cond/Dec C. 6/7/8 / Privacy

Verona/50x50 Métal et plastique rosace - avec ressort, carré 7 mm
Metal&plastic rose - springloaded

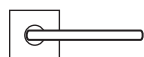

R035FS
BDC / Latch



R035FP
Cle L / Lock

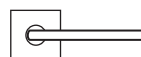

R035FY
Cle I / Cylinder

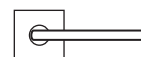

R035FW
Cond/Dec C. 6/7/8 / Privacy

Verona/FLQ Rosette abaissée métal - avec ressort, carré 7 mm / **Metal flat rose** - springloaded

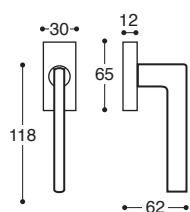

R0355I
Sans main / Without hand

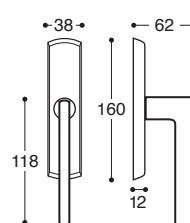

R0355K

Verona DK Poignée de fenetre
Mécan. 8 positions / Window handle - 8 pos. mech.

Verona Martellina Poignée de fenetre - crémona
Mécan. exclus / For window - cremon - mec. non included

* sur demande / on demand



Vieste.
design Ivo Pellegrini

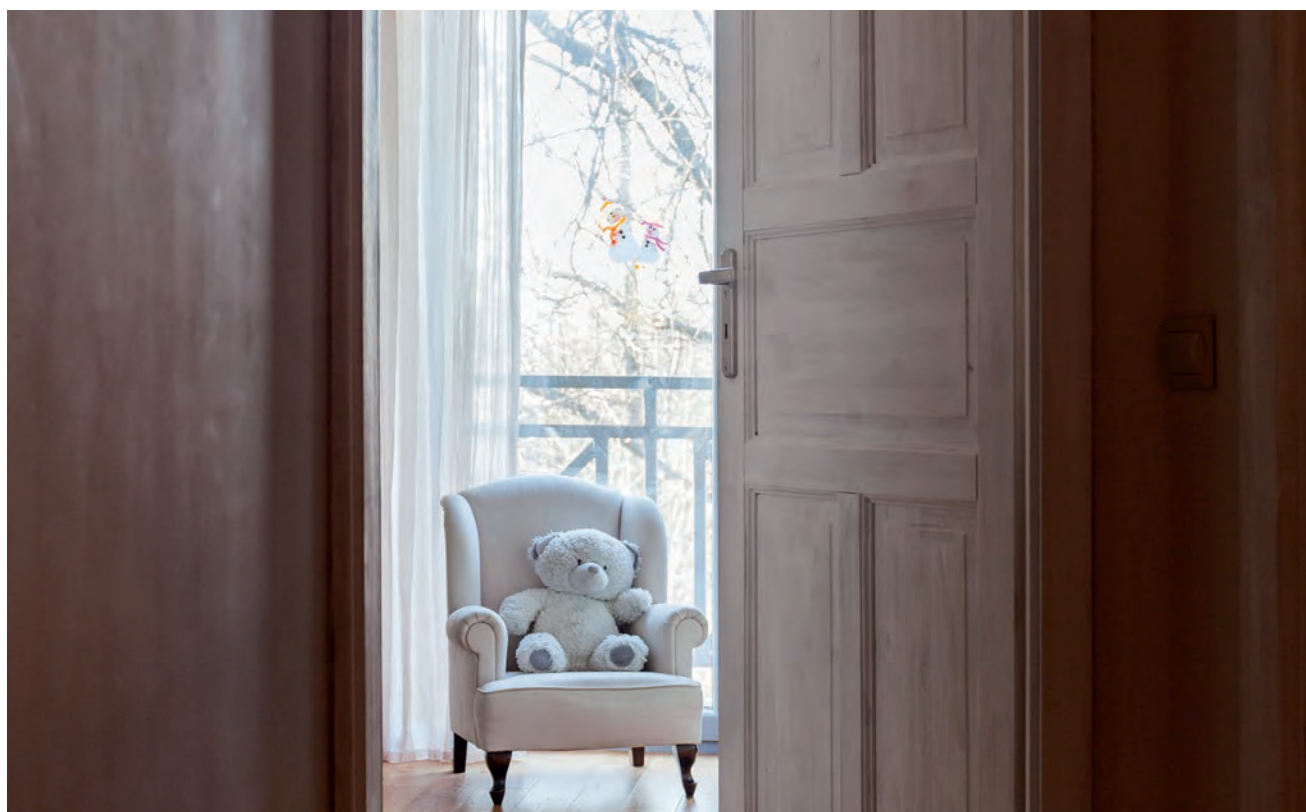
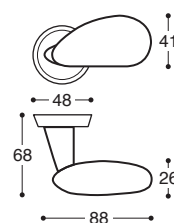

materiale / material
Ottone / Brass

standard

finiture standard / standard finishes



00 - Oro
Polished brass



06 - Cromo lucido
Polished chrome



08 - Cromo satinato
Satin chrome



BA - Bronzo gr. opaco
Mat satin bronze

finiture trendy / trendy finishes



G3 - Gun metal



15 - Nero opaco*
Mat black*



16 - Bianco*
White*



R01140
S/bocchetta / Latch

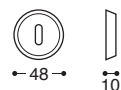

R01142
Patent / Lock

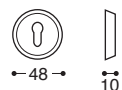

R01144
Yale / Cylinder

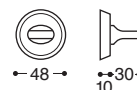

R01146
WC / Privacy - Q. 6/7/8

Vieste/HB11 Rosetta metallo&plastica - con molla / Metal&plastic rose - springloaded



R011S0
S/bocchetta / Latch

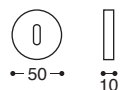

R011S2
Patent / Lock

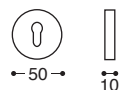

R011S4
Yale / Cylinder

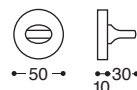

R011S6
WC / Privacy - Q. 6/7/8

Vieste/52D Rosetta metallo&plastica - con molla / Metal&plastic rose - springloaded

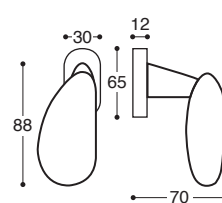

R0114J
SX / LH

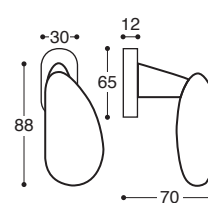

R0114I
DX / RH

Vieste DK - mov. 8 scatti
Window handle - 8 pos. mech.

* a richiesta / on demand

Material / material
Messing / Brass

standard

Standardveredelungen / standard finishes



00 - Messing poliert
Polished brass



06 - Chrom
Polished chrome



08 - Chrom matt
Satin chrome



BA - Matt Satin Bronze
Mat satin bronze

Trendy Veredelungen / trendy finishes



G3 - Gun metal



15 - Matt schwarz*
Mat black*



16 - Weiß*
White*



R011S0

Ohne Schlüssel / Latch



R011S3

BB / Lock



R011S5

PZ / Cylinder



R011S7

BAD S. 6/7/8 / Privacy

Vieste/52D Metall/Kunststoff Rosetten DIN 38 mm - Mit Feder / Metal&plastic rose - springloaded



R01110

Ohne Schlüssel / Latch



R01113

BB / Lock



R01115

PZ / Cylinder



R01117

BAD S. 6/7/8 / Privacy

Vieste/T11 Metall Rosetten DIN 38 mm - Mit Feder / Metal rose - springloaded

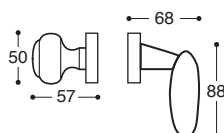

R011SD

PZ, Links / LH

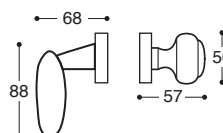

R011SC

PZ, Rechts / RH

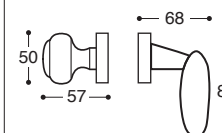

R0111D

PZ, Links / LH

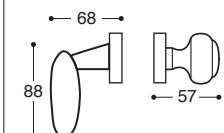

R0111C

PZ, Rechts / RH

Vieste/52D Metall/Kunststoff Rosetten - Wechselgarnitur

Vieste/T11 Metall Rosetten - Wechselgarnitur

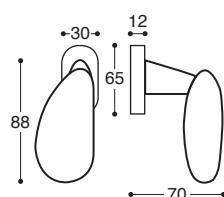

R0114J

Links / LH

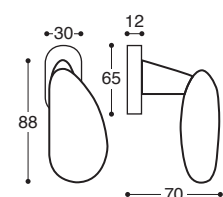

R0114I

Rechts / RH

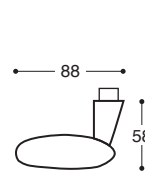

R01109

Links / LH

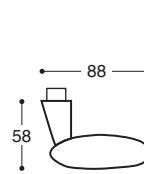

R01108

Rechts / RH

Vieste DK Fenstergriffe - Mit Rastung
Window handle - 8 pos. mech.

Vieste
Drückerlochteil - Ohne Rosetten

* auf Anfrage / on demand

matériau / material
Laiton / Brass

standard

finitions standards / standard finishes



00 - Laiton poli
Polished brass



06 - Chrome poli
Polished chrome



08 - Chrome satiné
Satin chrome



BA - Bronze mat satiné
Mat satin bronze

finitions trendy / trendy finishes



G3 - Gun metal



15 - Noir mat*
Mat black*



16 - Blanc*
White*



R0114S
BDC / Latch

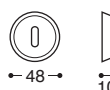

R0114P
Cle L / Lock

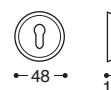

R0114Y
Cle I / Cylinder

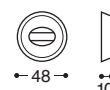

R0114W
Cond/Dec C. 6/7/8 / Privacy

Vieste/HB11 Métal et plastique rosace - avec ressort, carré 7 mm
Metal&plastic rose - springloaded



R011SS
BDC / Latch

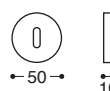

R011SP
Cle L / Lock



R011SY
Cle I / Cylinder

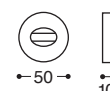

R011SW
Cond/Dec C. 6/7/8 / Privacy

Vieste/52D Métal et plastique rosace - avec ressort, carré 7 mm / **Metal&plastic rose** - springloaded

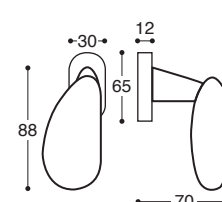

R0114J
Gauche / LH

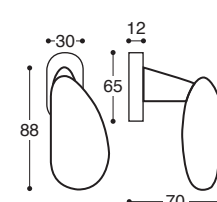

R0114I
Droite / RH

Vieste DK Poignée de fenêtre
Mécan. 8 positions / Window handle - 8 pos. mech.

* sur demande / on demand

Come ordinare - How to order - Wie bestellen - Comment commander

CODICE D'ACQUISTO* - PURCHASING CODE* - BESTELLNUMMER* - CODE D'ACHAT*



ESEMPIO / EXAMPLE / BEISPIEL / EXEMPLE:

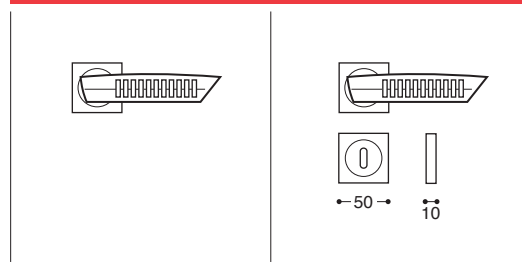

CODICE CODE KODE CODE	S/bocchetta / Latch	RSKY5	2	VERSIONE FUNCTION FUNKTION VERSION
	Skyline/Quad			

materiale / material

Ottone
Brass

finiture disponibili
finish available:

FINITURA FINISH FARBE FINITION	06 - Cromo lucido Polished chrome
	08 - Cromo satinato Satin chrome
	G3 - Gun metal

*Nel caso non fossero presenti tutti i tre riferimenti, usare in sequenza quelli/quello evidenziati.
*In case they were not all three references, use in sequence those/that highlighted.
*Für den Fall Sie nicht alle drei Referenzen finden sollten, schreiben sie sequentiellen.
*Dans le cas où ils ne sont pas tous les trois références, utilisent séquentiels / une évidence.

Accessori di complemento

Complementary accessories / Einrichtungszubehör / Accessoires

Set hotel	66
Maniglioni / Pull / Türgriff / Tirants	68
Pomoli / Knobs / Knöpfe / Bouton	69
Maniglie per porte scorrevoli / Sliding door handles Schiebetürmuschel / Poignée porte coulissant	71
Fermaporta - a pavimento / Doorstopper - floor Türstopper - für Fußboden / Butoir de porte - sol	71
Kit per porte scorrevoli / Sliding door handle set Komplettes Kit / Kit pour porte coulissant	72
Placche / Plates / Langschild / Plaques	91
Alzanti scorrevoli / Pull up handles for sliding doors Hebe-Schiebetürgriff / Poignées pour portes coulissantes	97

Accessori maniglia

Handle accessories / Griffzubehör / Accessoires poignées

Rosette tonda / Round roses Runde Rosetten / Rosaces arrondies	con sistema / with system / mit System / Avec système	
	HB6	Ø 50 mm - 10 mm spessore/thickness/Stärke/épaisseur 73
	T11	Ø 52 mm - 10 mm spessore/thickness/Stärke/épaisseur 74
	HB14	Ø 50 mm - 10 mm spessore/thickness/Stärke/épaisseur 76
	52D	Ø 50 mm - 10 mm spessore/thickness/Stärke/épaisseur 78
	HB11	Ø 48 mm - 10 mm spessore/thickness/Stärke/épaisseur 80
	FLT	Ø 52 mm - 5,5 mm spessore/thickness/Stärke/épaisseur 81
	HB10-45	Ø 45 mm - 10 mm spessore/thickness/Stärke/épaisseur 82

Rosette quadre / Squares roses Quadratische Rosetten Rosaces carrés	con sistema / with system / mit System / Avec système	
	QUAD	50x50 mm - 10 mm spessore/thickness/Stärke/épaisseur 83
	Q11	52x52 mm - 10 mm spessore/thickness/Stärke/épaisseur 84
	50x50	50x50 mm - 10 mm spessore/thickness/Stärke/épaisseur 86
	FLQ	52x52 mm - 5,5 mm spessore/thickness/Stärke/épaisseur 88

Rosette ovali e rettangolari Oval and rectangular roses Ovale und rechteckige Rosetten Rosaces ovales et rectangulaires	OVALE	31x62 mm - 10 mm spessore/thickness/Stärke/épaisseur 89
	RETTANGOLARE	31x62 mm - 10 mm spessore/thickness/Stärke/épaisseur 90

Serramenti / Window frames Fenster und Türen / Serrures	DK	30x65 mm - 12 mm spessore/thickness/Stärke/épaisseur 98
	DKR	30x65 mm - 12 mm spessore/thickness/Stärke/épaisseur 98
	CREMONESE	98

Finiture disponibili / Finishes available Verfügbare Veredelungen / Finitions disponibles	103
--	-----

Set hotel tondo / Round set hotel / Set Hotel rund / Ensemble hôtel arrondi

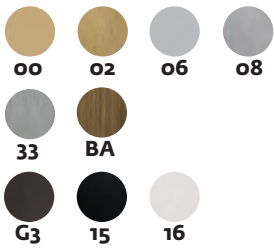

finiture standard / standard finishes
Standardveredelungen / finitions standards

- 00** - Oro / Polished brass
Messing poliert / Laiton poli
- 02** - Ottone satinato / Satin brass
Messing matt / Laiton satiné
- 06** - Cromo lucido / Polish. chrome
Chrom / Chrome poli
- 08** - Cromo satinato / Sat. chrome
Chrom matt / Chrome satiné
- 33** - Nickel sat. vern. / Satin nickel
Nickel matt / Nickel satiné
- BA** - Bronzo gr. opaco
Mat satin bronze
Matt satin Bronze
Bronze mat satiné

finiture trendy / trendy finishes
Trendy Veredelungen / finitions trendy

- G3** - Gun metal
- 15** - Nero opaco* / Mat black*
Matt schwarz* / Noir mat*
- 16** - Bianco* / White*
Weiß* / Blanc*

* a richiesta / on demand
auf Anfrage / sur demande

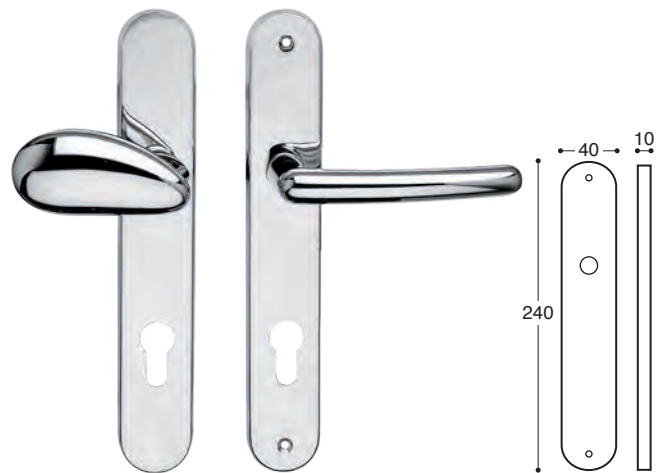
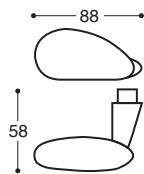

REBRPU

Set hotel con maniglia Bruges su placca ovale e pomolo fisso Vieste

Set hotel with Bruges handle on oval plaque and fixed knob Vieste

Set Hotel mit Bruges-Griff auf ovaler Platte und fixem Vieste-Knauf

Ensemble hôtel avec poignée Bruges sur plaque ovale et pommeau fixe Vieste

maniglie alternative: / alternative handles: Alternative Griffe: / poignées alternatives :

OLA

REOLPU



MILANO

REMIPU



COMPATTA

RECOPU



VERONA

REVEPU



DENVER

REDEPU



Set hotel quadro / Square set hotel / Set Hotel eckig / Ensemble hôtel carré

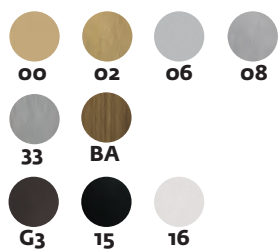

finiture standard / standard finishes
Standardveredelungen / finitions standards

- 00** - Oro / Polished brass
Messing poliert / Laiton poli
- 02** - Ottone satinato / Satin brass
Messing matt / Laiton satiné
- 06** - Cromo lucido / Polish. chrome
Chrom / Chrome poli
- 08** - Cromo satinato / Sat. chrome
Chrom matt / Chrome satiné
- 33** - Nickel sat. vern. / Satin nickel
Nickel matt / Nickel satiné
- BA** - Bronzo gr. opaco
Mat satin bronze
Matt satin Bronze
Bronze mat satiné

finiture trendy / trendy finishes
Trendy Veredelungen / finitions trendy

- G3** - Gun metal
- 15** - Nero opaco* / Mat black*
Matt schwarz* / Noir mat*
- 16** - Bianco* / White*
Weiß* / Blanc*

* a richiesta / on demand
auf Anfrage / sur demande



REDIRU

Set hotel con maniglia Dinamica su placca rettangolare e pomolo fisso rettangolare

Set hotel with Dinamica handle on rectangular plaque and fixed knob rectangular

Set Hotel mit Griff Dinamica auf rechteckiger Platte und fixem rechteckigem Knauf

Ensemble hôtel avec poignée dynamique sur plaque rectangulaire Et pommeau fixe rectangulaire

maniglie alternative: / alternative handles: Alternative Griffe: / poignées alternatives :



Maniglioni / Pull / Türgriff / Tirants Arco



standard

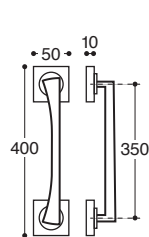

R00GWM
Maniglione
Fiss. frontale
o passante
Single pull
Face/passing fix.
Einzel Türgriff
Tirant

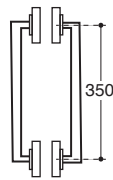

R00GWT
Paio maniglioni
Fiss. accoppiato
Pull set
back to back
Türgriff (paar weise)
Paire de tirants

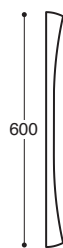

R00GWN
Maniglione
Fiss. frontale
o passante
Single pull
Face/passing fix.
Einzel Türgriff
Tirant

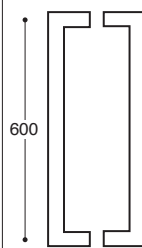

R00GWY
Paio maniglioni
Fiss. accoppiato
Pull set
back to back
Türgriff (paar weise)
Paire de tirants

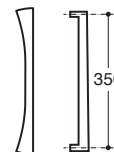

R00GWC
Maniglione
Fiss. frontale
o passante
Single pull
Face/passing fix.
Einzel Türgriff
Tirant

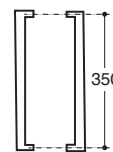

R00GWD
Paio maniglioni
Fiss. accoppiato
Pull set
back to back
Türgriff (paar weise)
Paire de tirants

finiture standard / standard finishes
Standardveredelungen / finitions standards

06 - Cromo lucido / Polished chrome Chrom / Chrome poli	•	•	•	•	•	•
08 - Cromo satinato / Satin chrome Chrom matt / Chrome satiné	•	•	•	•	•	•
33 - Nickel satinato vern. / Sat. nickel Nickel / Nickel satiné	•	•	•	•	•	•
BA - Bronzo gr. opaco / Mat sat. bronze Matt Sat. Bronze / Bronze mat sat.	•	•	•	•	•	•

finiture trendy / trendy finishes
Trendy Veredelungen / finitions trendy

G3 - Gun metal	•	•	•	•	•	•
15 - Nero opaco* / Mat black* Matt schwarz* / Noir mat*	•	•	•	•	•	•
16 - Bianco* / White* Weiß* / Blanc*	•	•	•	•	•	•

Arco Maniglioni / Pull / Türgriff / Tirants 350 mm 350-UG 600 mm 600-UG 350 mm 350-UG

* a richiesta / on demand / auf Anfrage / sur demande

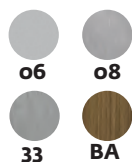

standard

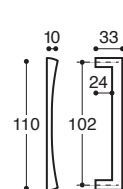

R5016102
Maniglia per mobili
Furniture handle
Moebelknöpfe
Poignée pur meuble

int 102 mm/4"

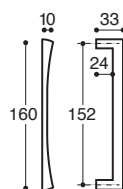

R5016152
Maniglia per mobili
Furniture handle
Moebelknöpfe
Poignée pur meuble

int 152 mm/6"

Arco Maniglioni / Pull / Türgriff / Tirants

4

6

**Fissaggio maniglioni / Pulls installation
Tuergriffen Befestigung / Montage des tirants**

vedi pag. _____ 104
see page / Siehe Seite / voir pag.

Pomoli / Knobs / Knöpfe / Boutons Ducale



standard

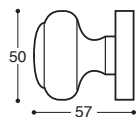

R03880



R03800
S/bocchetta / Latch
Ohne Schloss / BDC



R03802
Patent / Lock
BB / Cle L



R03804
Yale / Cylinder
PZ / Cle I



R03806
WC / Privacy
BAD
Cond/Dec C. 6 mm

finiture standard / standard finishes
Standardveredelungen / finitions standards

oo - Oro / Polished brass Messing poliert / Laiton poli	•	•	•	•	•
o6 - Cromo lucido / Polished chrome Chrom / Chrome poli	•	•	•	•	•
o8 - Cromo satinato / Satin chrome Chrom matt / Chrome satiné	•	•	•	•	•
BA - Bronzo gr. opaco / Mat sat. bronze Matt Sat. Bronze / Bronze mat sat.	•	•	•	•	•

Ducale

Pomolo singolo
Single knob
Einziges Knöpf / Bouton

Paio pomoli / Knob set
Knöpf (paar weise) / Paire boutons

Vienna



standard

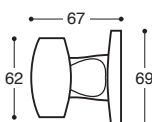

R01080

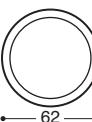

R01090
S/bocchetta / Latch
Ohne Schloss / BDC



R01092
Patent / Lock
BB / Cle L

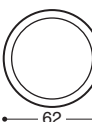

R01094
Yale / Cylinder
PZ / Cle I

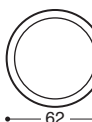

R01096
WC / Privacy
BAD
Cond/Dec C. 6 mm

finiture standard / standard finishes
Standardveredelungen / finitions standards

oo - Oro / Polished brass Messing poliert / Laiton poli	•	•	•	•	•
o6 - Cromo lucido / Polished chrome Chrom / Chrome poli	•	•	•	•	•
o8 - Cromo satinato / Satin chrome Chrom matt / Chrome satiné	•	•	•	•	•
BA - Bronzo gr. opaco / Mat sat. bronze Matt Sat. Bronze / Bronze mat sat.	•	•	•	•	•

Vienna

Pomolo singolo
Single knob
Einziges Knöpf / Bouton

Paio pomoli / Knob set
Knöpf (paar weise) / Paire boutons

Pomoli / Knobs / Knöpfe / Boutons Vieste

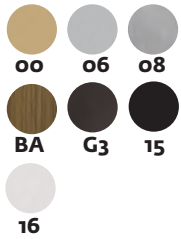

standard

R01148 SX / LH Links / Gauche	R01149 DX / RH Rechts / Droite	R01140 S/bocchetta / Latch Ohne Schloss / BDC	R01142 Patent / Lock BB / Cle L	R01144 Yale / Cylinder PZ / Cle I	R01146 WC / Privacy BAD Cond/Dec C. 6 mm

finiture standard / standard finishes
Standardveredelungen / finitions standards

00 - Oro / Polished brass Messing poliert / Laiton poli	<input type="checkbox"/>	<input type="checkbox"/>	<input type="checkbox"/>	<input type="checkbox"/>	<input type="checkbox"/>	<input type="checkbox"/>
06 - Cromo lucido / Polished chrome Chrom / Chrome poli	<input type="checkbox"/>	<input type="checkbox"/>	<input type="checkbox"/>	<input type="checkbox"/>	<input type="checkbox"/>	<input type="checkbox"/>
08 - Cromo satinato / Satin chrome Chrom matt / Chrome satiné	<input type="checkbox"/>	<input type="checkbox"/>	<input type="checkbox"/>	<input type="checkbox"/>	<input type="checkbox"/>	<input type="checkbox"/>
BA - Bronzo gr. opaco / Mat sat. bronze Matt Sat. Bronze / Bronze mat sat.	<input type="checkbox"/>	<input type="checkbox"/>	<input type="checkbox"/>	<input type="checkbox"/>	<input type="checkbox"/>	<input type="checkbox"/>

finiture trendy / trendy finishes
Trendy Veredelungen / finitions trendy

G3 - Gun metal	<input type="checkbox"/>	<input type="checkbox"/>	<input type="checkbox"/>	<input type="checkbox"/>	<input type="checkbox"/>	<input type="checkbox"/>
15 - Nero opaco* / Mat black* Matt schwarz* / Noir mat*	<input type="checkbox"/>	<input type="checkbox"/>	<input type="checkbox"/>	<input type="checkbox"/>	<input type="checkbox"/>	<input type="checkbox"/>
16 - Bianco* / White* Weiß* / Blanc*	<input type="checkbox"/>	<input type="checkbox"/>	<input type="checkbox"/>	<input type="checkbox"/>	<input type="checkbox"/>	<input type="checkbox"/>

Vieste

Pomolo singolo
Single knob
Einziges Knöpf / Bouton

Paio pomoli / Knob set
Knöpf (paar weise) / Paire boutons

* a richiesta / on demand / auf Anfrage / sur demande

Quadro

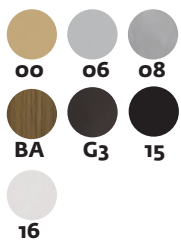

standard

RRET48 SX / LH Links / Gauche	RRET49 DX / RH Rechts / Droite	RRET50 S/bocchetta / Latch Ohne Schloss / BDC	RRET52 Patent / Lock BB / Cle L	RRET54 Yale / Cylinder PZ / Cle I	RRET56 WC / Privacy BAD Cond/Dec C. 6 mm

finiture standard / standard finishes
Standardveredelungen / finitions standards

00 - Oro / Polished brass Messing poliert / Laiton poli	<input type="checkbox"/>	<input type="checkbox"/>	<input type="checkbox"/>	<input type="checkbox"/>	<input type="checkbox"/>	<input type="checkbox"/>
06 - Cromo lucido / Polished chrome Chrom / Chrome poli	<input type="checkbox"/>	<input type="checkbox"/>	<input type="checkbox"/>	<input type="checkbox"/>	<input type="checkbox"/>	<input type="checkbox"/>
08 - Cromo satinato / Satin chrome Chrom matt / Chrome satiné	<input type="checkbox"/>	<input type="checkbox"/>	<input type="checkbox"/>	<input type="checkbox"/>	<input type="checkbox"/>	<input type="checkbox"/>
BA - Bronzo gr. opaco / Mat sat. bronze Matt Sat. Bronze / Bronze mat sat.	<input type="checkbox"/>	<input type="checkbox"/>	<input type="checkbox"/>	<input type="checkbox"/>	<input type="checkbox"/>	<input type="checkbox"/>

finiture trendy / trendy finishes
Trendy Veredelungen / finitions trendy

G3 - Gun metal	<input type="checkbox"/>	<input type="checkbox"/>	<input type="checkbox"/>	<input type="checkbox"/>	<input type="checkbox"/>	<input type="checkbox"/>
15 - Nero opaco* / Mat black* Matt schwarz* / Noir mat*	<input type="checkbox"/>	<input type="checkbox"/>	<input type="checkbox"/>	<input type="checkbox"/>	<input type="checkbox"/>	<input type="checkbox"/>
16 - Bianco* / White* Weiß* / Blanc*	<input type="checkbox"/>	<input type="checkbox"/>	<input type="checkbox"/>	<input type="checkbox"/>	<input type="checkbox"/>	<input type="checkbox"/>

Quadro

Pomolo singolo
Single knob
Einziges Knöpf / Bouton

Paio pomoli / Knob set
Knöpf (paar weise) / Paire boutons

Maniglie per porte scorrevoli / Sliding door handles Schiebetürmuschel / Poignée porte coulissant

HS - 3

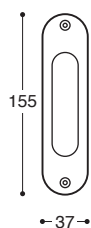
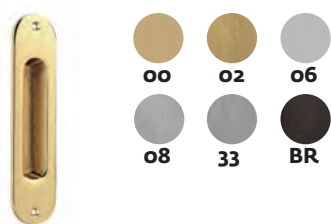

HS - 3

RHS300

Senza foro chiave / Latch
Ohne Schlüsselloch / BDC

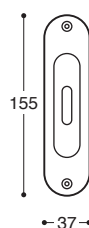

HS - 3

RHS301

Con foro chiave / Lock
Mit Schlüsselloch / Clé



finiture standard / standard finishes
Standardveredelungen / finitions standards

00 - Oro / Polished brass Messing poliert / Laiton poli	•	•
02 - Ottone satinato / Satin brass Messing brass / Laiton satiné	•	•
06 - Cromo lucido / Polished chrome Chrom / Chrom poli	•	•
08 - Cromo satinato / Satin chrome Chrom matt / Chrome satiné	•	•
33 - Nickel sat. vern. / Satin nickel Nickel matt / Nickel satiné	•	•
BR - Bronzo opaco / Mat bronze Matt Bronze / Bronze mat	•	•

Fermaporta - a pavimento / Doorstopper - floor Türstopper - für Fußboden / Butoir de porte - sol

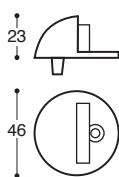
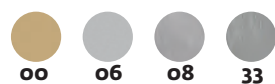

PA 1
RPA100

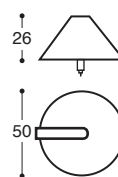

PA 2
RPA200

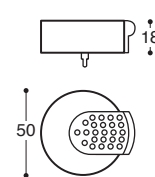

PA 3
RPA300



finiture standard / standard finishes
Standardveredelungen / finitions standards

00 - Oro / Polished brass Messing poliert / Laiton poli	•	•	•
06 - Cromo lucido / Polished chrome Chrom / Chrom poli	•	•	•
08 - Cromo satinato / Satin chrome Chrom matt / Chrome satiné	•	•	•
33 - Nickel sat. vern. / Satin nickel Nickel matt / Nickel satiné	•	•	•

Kit per porte scorrevoli / Sliding door handle set Komplettes Kit / Kit pour porte coulissant

Quadro

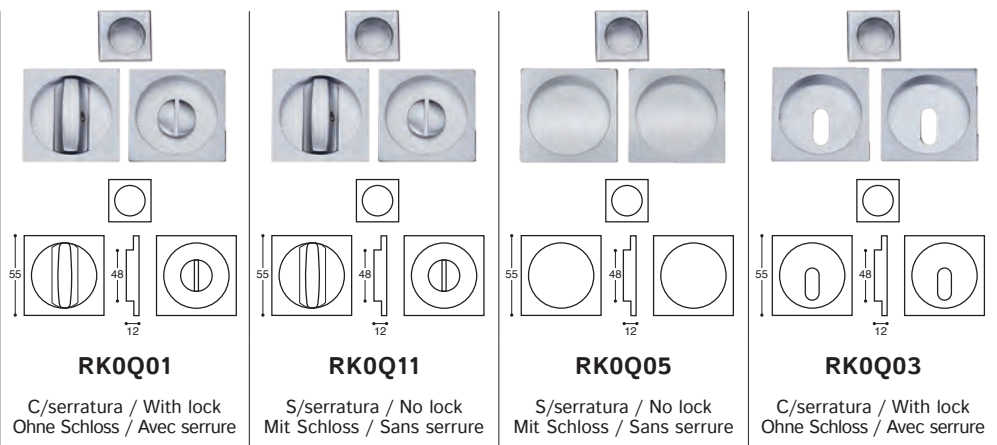

finiture standard / standard finishes
Standardveredelungen / finitions standards

- oo** - Oro / Polished brass
Messing poliert / Laiton poli
- o6** - Cromo lucido / Polished chrome
Chrom / Chrom poli
- o8** - Cromo satinato / Satin chrome
Chrom matt / Chrome satiné

E-Kit Nr. 0 Quad

entrata 50 mm
50 mm bakset
50 mm Dornaß
50 mm distance d'entrée

C-Kit Nr. 7 Quad

B1-Kit Nr. 0 Quad

entrata 50 mm
50 mm bakset
50 mm Dornaß
50 mm distance d'entrée



serratura entrata 30 frontale da 16
30 mm backset, 16 mm front plate

serratura entrata 50 frontale da 16
50 mm backset, 16 mm front plate

E - 30

A - 50

B - 16

E - 50

A - 70

B - 16

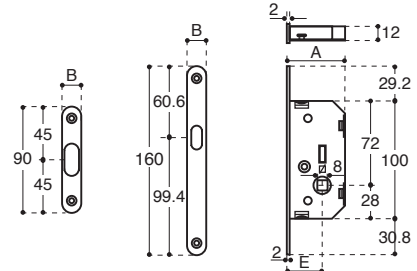

Tondo

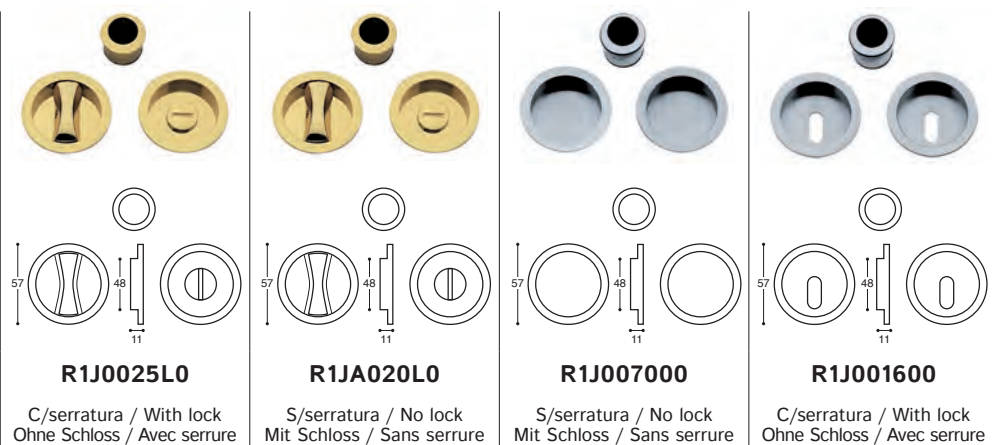

finiture standard / standard finishes
Standardveredelungen / finitions standards

- oo** - Oro / Polished brass
Messing poliert / Laiton poli
- o6** - Cromo lucido / Polished chrome
Chrom / Chrom poli
- o8** - Cromo satinato / Satin chrome
Chrom matt / Chrome satiné

E-Kit Nr. 0

entrata 50 mm
50 mm bakset
50 mm Dornaß
50 mm distance d'entrée

C-Kit Nr. 7

B1-Kit Nr. 0

entrata 50 mm
50 mm bakset
50 mm Dornaß
50 mm distance d'entrée

Rosette tonda / Round roses / Rosaces arrondies
HB6 sistema / system / système

oo **o6** **o8** **33**
SL **BA** **G3**

Rosetta
 Rose
 Rosace
RHB6X0

Bocchetta
 Escutcheon
 Rosace de cle
 Patent / Lock Cle L | Yale / Cylinder Cle I
R13717 | **R13719**

WC
 Privacy
 Cond/Dec
R89600

finiture standard / standard finishes
 finitions standards

oo - Oro / Polished brass Laiton poli	•	•	•	•
o6 - Cromo lucido / Polish. chrome Chrome poli	•	•	•	•
o8 - Cromo satinato / Sat. chrome Chrome satiné	•	•	•	•
33 - Nickel sat. vern. / Satin nickel Nickel satiné	•	•	•	•
SL - Silver	•	•	•	•
BA - Bronzo gr. opaco Mat satin bronze Bronze mat satiné	•	•	•	•

finiture trendy / trendy finishes
 finitions trendy

G3 - Gun metal	•	•	•	•
-----------------------	---	---	---	---

HB6

HB6

HB6/WC



Rosette tonda / Round roses / Rosaces arrondies
T11 sistema / system / système

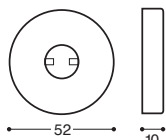
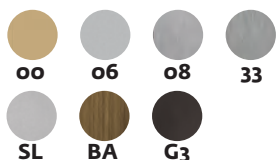

**Rosetta
Rose
Rosace**

RT11X0

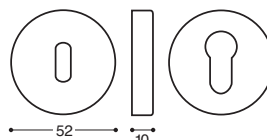

**Bocchetta
Escutcheon
Rosace de cle**

Patent / Lock
Cle L

R13037

Yale / Cylinder
Cle I

R13038

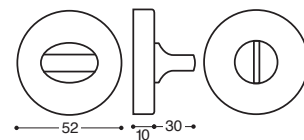

**WC
Privacy
Cond/Dec**

R18751



finiture standard / standard finishes
 finitions standards

oo - Oro / Polished brass Laiton poli	•	•	•	•
o6 - Cromo lucido / Polish. chrome Chrome poli	•	•	•	•
o8 - Cromo satinato / Sat. chrome Chrome satiné	•	•	•	•
33 - Nickel sat. vern. / Satin nickel Nickel satiné	•	•	•	•
SL - Silver	•	•	•	•
BA - Bronzo gr. opaco Mat satin bronze Bronze mat satiné	•	•	•	•

finiture trendy / trendy finishes
 finitions trendy

G3 - Gun metal	•	•	•	•
-----------------------	---	---	---	---

T11

T11

T11/WC



Base con molla premontata
 Base with pre-assembled spring
 Base avec ressort prémonté

Runde Rosetten T11-System

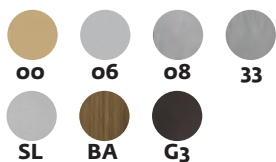

standard

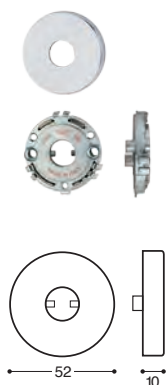

Rosetten
DIN 38 mm

RT11X3

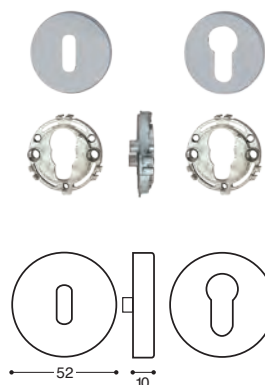

Schlüssen rosetten
DIN 38 mm

BB	PZ
R13044	R13045



Bad
DIN 38 mm

R18759

Standardveredelungen

oo - Messing poliert	•	•	•	•
o6 - Chrom	•	•	•	•
o8 - Chrom matt	•	•	•	•
33 - Nickel matt	•	•	•	•
SL - Silber	•	•	•	•
BA - Matt satin Bronze	•	•	•	•

Trendy Veredelungen

G3 - Gun metal	•	•	•	•
-----------------------	---	---	---	---

T11

T11

T11/WC



Basis mit vormontierter Feder

Rosette tonde / Round roses / Rosaces arrondies
HB14 sistema / system / système

oo **o6** **o8** **33**
SL **BA** **G3**

Rosetta
Rose
Rosace

Bocchetta
Escutcheon
Rosace de cle

WC
Privacy
Cond/Dec

RHB140 **R13700** **R13701** **R89660**



finiture standard / standard finishes
 finitions standards

oo - Oro / Polished brass Laiton poli	•	•	•	•
o6 - Cromo lucido / Polish. chrome Chrome poli	•	•	•	•
o8 - Cromo satinato / Sat. chrome Chrome satiné	•	•	•	•
33 - Nickel sat. vern. / Satin nickel Nickel satiné	•	•	•	•
SL - Silver	•	•	•	•
BA - Bronzo gr. opaco Mat satin bronze Bronze mat satiné	•	•	•	•

finiture trendy / trendy finishes
 finitions trendy

G3 - Gun metal	•	•	•	•
-----------------------	---	---	---	---

HB14

HB14

HB14/WC



Runde Rosetten HB14-System

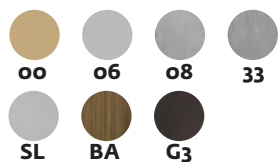

standard



Rosetten
DIN 38 mm

RHB143

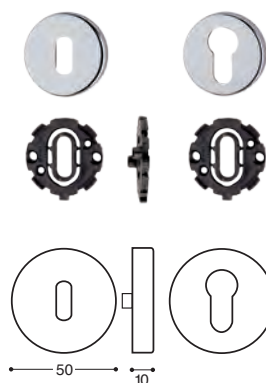

Schlüsser rosetten
DIN 38 mm

BB	PZ
R13702	R13703

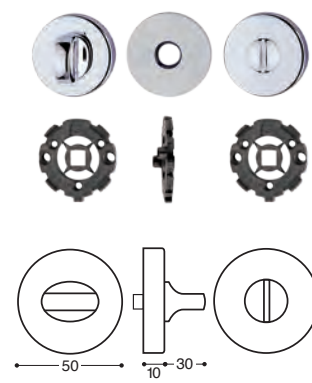

Bad
DIN 38 mm

R89663

Standardveredelungen

oo - Messing poliert	•	•	•	•
o6 - Chrom	•	•	•	•
o8 - Chrom matt	•	•	•	•
33 - Nickel matt	•	•	•	•
SL - Silber	•	•	•	•
BA - Matt satin Bronze	•	•	•	•

Trendy Veredelungen

G3 - Gun metal	•	•	•	•
-----------------------	---	---	---	---

HB14

HB14

HB14/WC



Rosette tonda / Round roses / Rosaces arrondies
52D sistema / system / système

<p>Rosetta Rose Rosace</p> <p>R52DX0</p>	<p>Bocchetta Escutcheon Rosace de cle</p> <p>Patent / Lock Cle L Yale / Cylinder Cle I</p> <p>R13039 R13040</p>	<p>WC Privacy Cond/Dec</p> <p>R18758</p>
---	--	---



finiture standard / standard finishes
 finitions standards

00 - Oro / Polished brass Laiton poli	•	•	•	•
06 - Cromo lucido / Polish. chrome Chrome poli	•	•	•	•
08 - Cromo satinato / Sat. chrome Chrome satiné	•	•	•	•
33 - Nickel sat. vern. / Satin nickel Nickel satiné	•	•	•	•
SL - Silver	•	•	•	•
BA - Bronzo gr. opaco Mat satin bronze Bronze mat satiné	•	•	•	•

finiture trendy / trendy finishes
 finitions trendy

G3 - Gun metal	•	•	•	•
-----------------------	---	---	---	---

52D

52D

52D/WC



Base con molla premontata
 Base with pre-assembled spring
 Base avec ressort prémonté

Runde Rosetten 52D-System

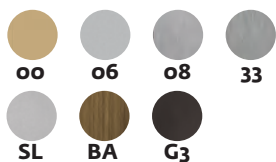

standard

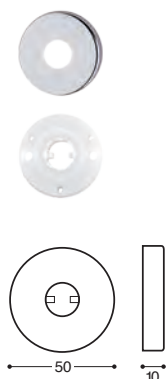

Rosetten
DIN 38 mm

R52DX3

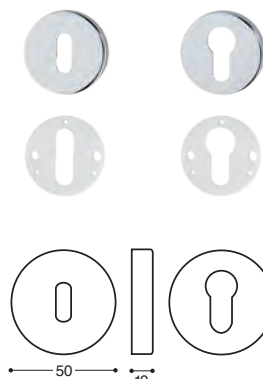

Schlüsser rosetten
DIN 38 mm

BB	PZ
R13045	R13046



Bad
DIN 38 mm

R18760

Standardveredelungen

oo - Messing poliert	•	•	•	•
o6 - Chrom	•	•	•	•
o8 - Chrom matt	•	•	•	•
33 - Nickel matt	•	•	•	•
SL - Silber	•	•	•	•
BA - Matt satin Bronze	•	•	•	•

Trendy Veredelungen

G3 - Gun metal	•	•	•	•
----------------	---	---	---	---

52D

52D

52D/WC



Basis mit vormontierter Feder

Rosette tonda / Round roses / Rosaces arrondies
HB11 sistema / system / système

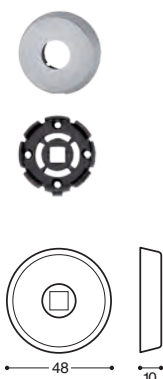

**Rosetta
Rose
Rosace**

RHB110

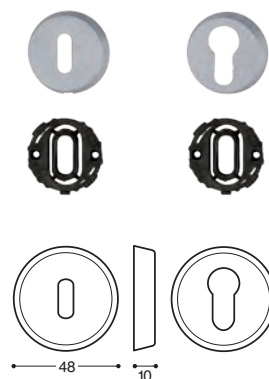

**Bocchetta
Escutcheon
Rosace de cle**

Patent / Lock
Cle L

Yale / Cylinder
Cle I

R13705

R13707

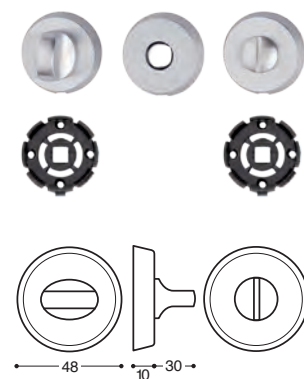

**WC
Privacy
Cond/Dec**

R89640



finiture standard / standard finishes
 finitions standards

oo - Oro / Polished brass Laiton poli	•	•	•	•
o6 - Cromo lucido / Polish. chrome Chrome poli	•	•	•	•
o8 - Cromo satinato / Sat. chrome Chrome satiné	•	•	•	•
33 - Nickel sat. vern. / Satin nickel Nickel satiné	•	•	•	•
SL - Silver	•	•	•	•
BA - Bronzo gr. opaco Mat satin bronze Bronze mat satiné	•	•	•	•

finiture trendy / trendy finishes
 finitions trendy

G3 - Gun metal	•	•	•	•
-----------------------	---	---	---	---

HB11

HB11

HB11/WC



Rosette tonda / Round roses / Rosaces arrondies
 FLT sistema / system / système

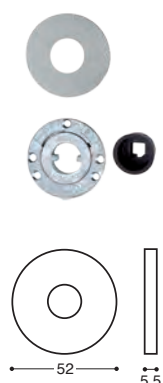
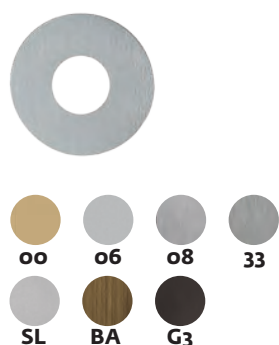

Rosetta
Rose
Rosace

RFLTX0

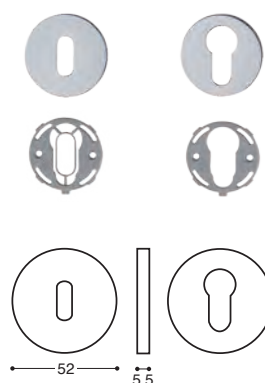

Bocchetta
Escutcheon
Rosace de cle

Patent / Lock Cle L Yale / Cylinder Cle I

R13035

R13036



WC
Privacy
Cond/Dec

R896FT



finiture standard / standard finishes
 finitions standards

00 - Oro / Polished brass Laiton poli	•	•	•	•
06 - Cromo lucido / Polish. chrome Chrome poli	•	•	•	•
08 - Cromo satinato / Sat. chrome Chrome satiné	•	•	•	•
33 - Nickel sat. vern. / Satin nickel Nickel satiné	•	•	•	•
SL - Silver	•	•	•	•
BA - Bronzo gr. opaco Mat satin bronze Bronze mat satiné	•	•	•	•

finiture trendy / trendy finishes
 finitions trendy

G3 - Gun metal	•	•	•	•
-----------------------	---	---	---	---

FLT

FLT

FLT/WC



Base con molla premontata
 Base with pre-assembled spring
 Base avec ressort prémonté

Rosette tonde / Round roses / Rosaces arrondies
HB10-45 sistema / system / système

oo **o6** **o8** **33**
SL **BA** **G3**

Rosetta
Rose
Rosace

Bocchetta
Escutcheon
Rosace de cle

WC
Privacy
Cond/Dec

R45XX00 **R13711** **R13713** **R89610**



finiture standard / standard finishes
 finitions standards

oo - Oro / Polished brass Laiton poli	•	•	•	•
o6 - Cromo lucido / Polish. chrome Chrome poli	•	•	•	•
o8 - Cromo satinato / Sat. chrome Chrome satiné	•	•	•	•
33 - Nickel sat. vern. / Satin nickel Nickel satiné	•	•	•	•
SL - Silver	•	•	•	•
BA - Bronzo gr. opaco Mat satin bronze Bronze mat satiné	•	•	•	•

finiture trendy / trendy finishes
 finitions trendy

G3 - Gun metal	•	•	•	•
-----------------------	---	---	---	---

HB10-45

HB10-45

HB10-45/WC



Rosette quadrate / Squares roses / Rosaces carrés
QUAD sistema / system / système

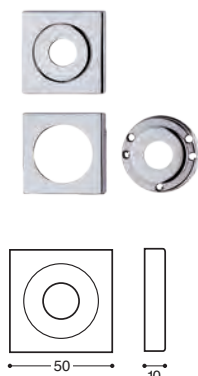
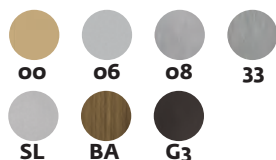

**Rosetta
Rose
Rosace**

RQUAD0

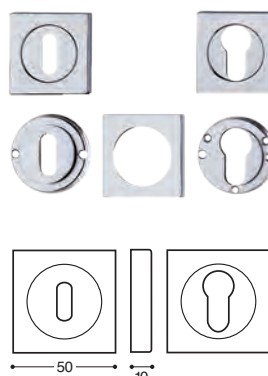

**Bocchetta
Escutcheon
Rosace de cle**

Patent / Lock
Cle L

R13052

Yale / Cylinder
Cle I

R13053

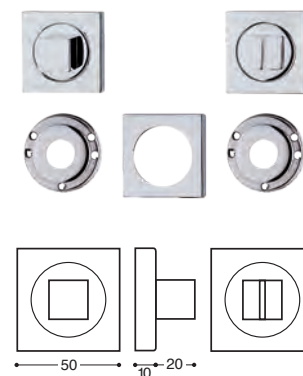

**WC
Privacy
Cond/Dec**

R18750



finiture standard / standard finishes
 finitions standards

oo - Oro / Polished brass Laiton poli	•	•	•	•
o6 - Cromo lucido / Polish. chrome Chrome poli	•	•	•	•
o8 - Cromo satinato / Sat. chrome Chrome satiné	•	•	•	•
33 - Nickel sat. vern. / Satin nickel Nickel satiné	•	•	•	•
SL - Silver	•	•	•	•
BA - Bronzo gr. opaco Mat satin bronze Bronze mat satiné	•	•	•	•

finiture trendy / trendy finishes
 finitions trendy

G3 - Gun metal	•	•	•	•
-----------------------	---	---	---	---

QUAD

QUAD

QUAD/WC



Rosette quadrate / Squares roses / Rosaces carrés

Q11 sistema / system / système

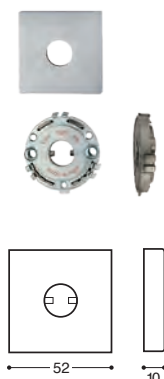
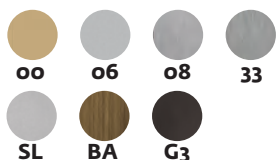

Rosetta
Rose
Rosace

RQ11X0

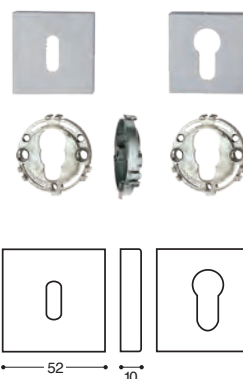

Bocchetta
Escutcheon
Rosace de cle

Patent / Lock
Cle L

R13030

Yale / Cylinder
Cle I

R13031

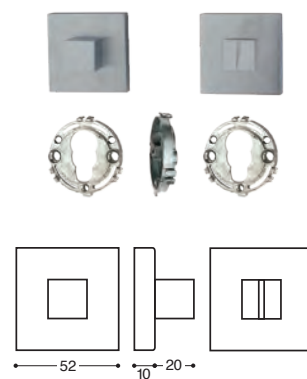

WC
Privacy
Cond/Dec

R18753



finiture standard / standard finishes
finitions standards

oo - Oro / Polished brass Laiton poli	•	•	•	•
o6 - Cromo lucido / Polish. chrome Chrome poli	•	•	•	•
o8 - Cromo satinato / Sat. chrome Chrome satiné	•	•	•	•
33 - Nickel sat. vern. / Satin nickel Nickel satiné	•	•	•	•
SL - Silver	•	•	•	•
BA - Bronzo gr. opaco Mat satin bronze Bronze mat satiné	•	•	•	•

finiture trendy / trendy finishes
finitions trendy

G3 - Gun metal	•	•	•	•
-----------------------	---	---	---	---

Q11

Q11

Q11/WC



Base con molla premontata
Base with pre-assembled spring
Base avec ressort prémonté

Quadratische Rosetten Q11-System

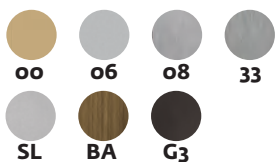

standard

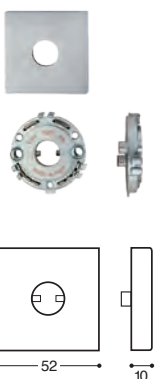

Rosetten
DIN 38 mm

RQ11X3

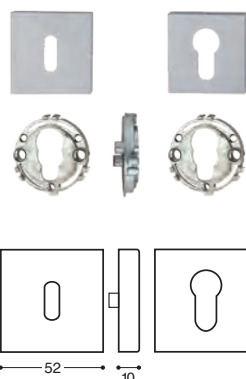

Schlüsser rosetten
DIN 38 mm

BB	PZ
R13048	R13049

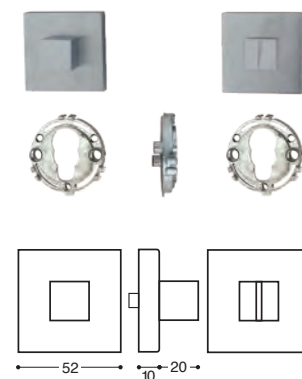

Bad
DIN 38 mm

R18762

Standardveredelungen

oo - Messing poliert	•	•	•	•
o6 - Chrom	•	•	•	•
o8 - Chrom matt	•	•	•	•
33 - Nickel matt	•	•	•	•
SL - Silber	•	•	•	•
BA - Matt satin Bronze	•	•	•	•

Trendy Veredelungen

G3 - Gun metal	•	•	•	•
----------------	---	---	---	---

Q11

Q11

Q11/WC



Basis mit vormontierter Feder

Rosette quadrate / Squares roses / Rosaces carrés 50x50 sistema / system / système

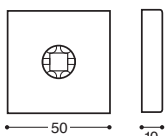

**Rosetta
Rose
Rosace**

R50X50

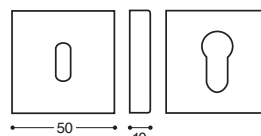

**Bocchetta
Escutcheon
Rosace de cle**

Patent / Lock
Cle L

R13033

Yale / Cylinder
Cle I

R13034

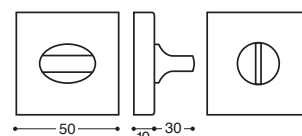

**WC
Privacy
Cond/Dec**

R18754



finiture standard / standard finishes
finitions standards

00 - Oro / Polished brass Laiton poli	•	•	•	•
06 - Cromo lucido / Polish. chrome Chrome poli	•	•	•	•
08 - Cromo satinato / Sat. chrome Chrome satiné	•	•	•	•
33 - Nickel sat. vern. / Satin nickel Nickel satiné	•	•	•	•
SL - Silver	•	•	•	•
BA - Bronzo gr. opaco Mat satin bronze Bronze mat satiné	•	•	•	•

finiture trendy / trendy finishes
finitions trendy

G3 - Gun metal	•	•	•	•
-----------------------	---	---	---	---

50x50

50x50

50x50/WC



Base con molla premontata
Base with pre-assembled spring
Base avec ressort prémonté

Quadratische Rosetten 50x50-System

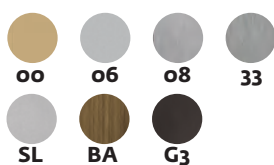

standard

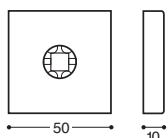

Rosetten
DIN 38 mm

R50X53

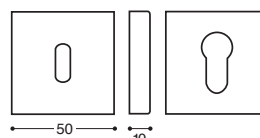

Schlüsser rosetten
DIN 38 mm

BB

PZ

R13055

R13056

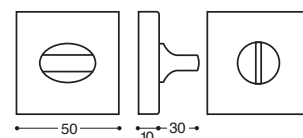

Bad
DIN 38 mm

R18760

Standardveredelungen

oo - Messing poliert	•	•	•	•
o6 - Chrom	•	•	•	•
o8 - Chrom matt	•	•	•	•
33 - Nickel matt	•	•	•	•
SL - Silber	•	•	•	•
BA - Matt satin Bronze	•	•	•	•

Trendy Veredelungen

G3 - Gun metal	•	•	•	•
-----------------------	---	---	---	---

50x50

50x50

50x50/WC





Basis mit vormontierter Feder

Rosette quadrate / Squares roses / Rosaces carrés
FLQ sistema / system / système





oo



o6



o8

33

SL

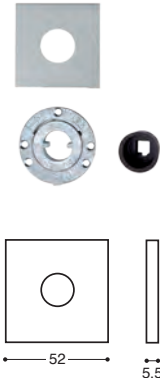

BA

G3

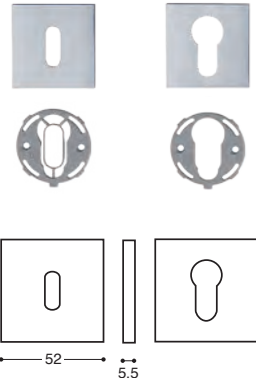

**Rosetta
Rose
Rosace**

RFLQX0



**Bocchetta
Escutcheon
Rosace de cle**

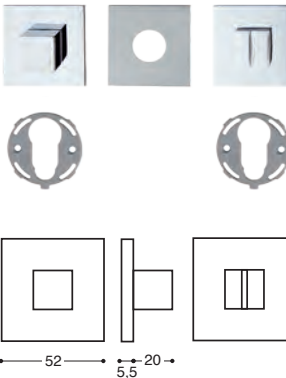

Patent / Lock Cle L Yale / Cylinder Cle I

R13042 R13043



**WC
Privacy
Cond/Dec**

RQUAFQ

standard  

finiture standard / standard finishes
 finitions standards

oo - Oro / Polished brass Laiton poli	•	•	•	•
o6 - Cromo lucido / Polish. chrome Chrome poli	•	•	•	•
o8 - Cromo satinato / Sat. chrome Chrome satiné	•	•	•	•
33 - Nickel sat. vern. / Satin nickel Nickel satiné	•	•	•	•
SL - Silver	•	•	•	•
BA - Bronzo gr. opaco Mat satin bronze Bronze mat satiné	•	•	•	•

finiture trendy / trendy finishes
 finitions trendy

G3 - Gun metal	•	•	•	•
-----------------------	---	---	---	---

FLQ

FLQ

FLQ/WC

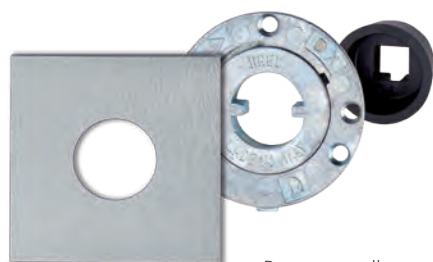



Base con molla premontata
 Base with pre-assembled spring
 Base avec ressort prémonté

Rosette ovali / Oval roses / Ovale Rosetten / Rosaces ovales





oo



o6



o8

33



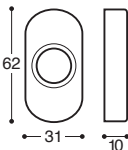

SL

BA



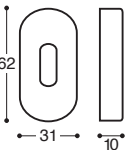
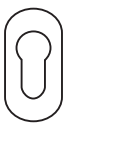

G3

RROVAL

RBOVA1 **RBOVA2**

R8960V

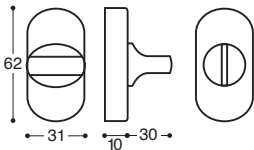
Rosetta / Rose
Rosetten / Rosace

Bocchetta / Escutcheon
Schlüssen rosetten
Rosace de cle

Patent / Lock BB / Cle L Yale / Cylinder PZ / Cle I

WC / Privacy
BAD / Cond/Dec

standard 

finiture standard / standard finishes
Standardveredelungen / finitions standards

oo - Oro / Polished brass Laiton poli	•	•	•	•
o6 - Cromo lucido / Polish. chrome Chrome poli	•	•	•	•
o8 - Cromo satinato / Sat. chrome Chrome satiné	•	•	•	•
33 - Nickel sat. vern. / Satin nickel Nickel satiné	•	•	•	•
SL - Silver	•	•	•	•
BA - Bronzo gr. opaco Mat satin bronze Bronze mat satiné	•	•	•	•

Ovale

Ovale

Ovale/WC



Rosette rettangolari / Rectangular roses Rechteckige Rosetten / Rosaces rectangulaires

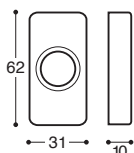
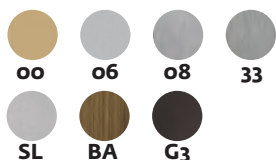

**Rosetta / Rose
Rosetten / Rosace**

RRETT

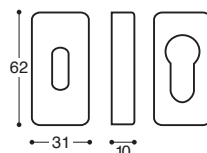

**Bocchetta / Escutcheon
Schlüssens rosetten
Rosace de cle**

Patent / Lock
BB / Cle L

Yale / Cylinder
PZ / Cle I

RBRET1

RBRET2

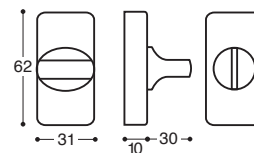

**WC / Privacy
BAD / Cond/Dec**

R896RE



finiture standard / standard finishes
Standardveredelungen / finitions standards

oo - Oro / Polished brass Messing poliert / Laiton poli	•	•	•	•
o6 - Cromo lucido / Polish. chrome Chrom / Chrome poli	•	•	•	•
o8 - Cromo satinato / Sat. chrome Chrom matt / Chrome satiné	•	•	•	•
33 - Nickel sat. vern. / Satin nickel Nickel matt / Nickel satiné	•	•	•	•
SL - Silver / Silber	•	•	•	•
BA - Bronzo gr. opaco Mat satin bronze Matt satin Bronze Bronze mat satiné	•	•	•	•

Rettangolare

Rettangolare

Rettangolare/WC



Placche / Plates / Langschild / Plaques Sidney

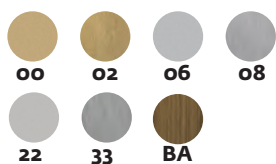

Cieca / Latch Ohne Schlüssel / BDC	Patent / Lock BB / Cle L	Yale / Cylinder PZ / Cle I	WC / Privacy BAD / Cond/Dec
R22947	R22947	R22947	R22947
	B57 - 57 mm	D55 - 55 mm	I57 - 57 mm
	B70 - 70 mm	D57 - 57 mm	I63 - 63 mm
	B72 - 72 mm	D70 - 70 mm	I70 - 70 mm
	B75 - 75 mm	D72 - 72 mm	I78 - 78 mm
	B90 - 90 mm	D85 - 85 mm	I90 - 90 mm
	B11 - 110 mm	D92 - 92 mm	I11 - 110 mm
		D11 - 110 mm	
Altre distanze a richiesta / Other distances on request / Weitere Entfernungen auf Anfrage / D'autres distances sur demande			
000	BXX	DXX	IXX



finiture standard / standard finishes
Standardveredelungen / finitions standards

00 - Oro / Polished brass Messing poliert / Laiton poli	•	•	•	•
02 - Ottone satinato / Satin brass Messing matt / Laiton satiné	•	•	•	•
06 - Cromo lucido / Polish. chrome Chrom / Chrome poli	•	•	•	•
08 - Cromo satinato / Sat. chrome Chrom matt / Chrome satiné	•	•	•	•
22 - Nickel lucido / Polished nickel Nickel / Nickel poli	•	•	•	•
33 - Nickel sat. vern. / Satin nickel Nickel matt / Nickel satiné	•	•	•	•
BA - Bronzo gr. opaco Mat satin bronze Matt satin Bronze Bronze mat satiné	•	•	•	•

Sidney

Placche / Plates / Langschild / Plaques Elba

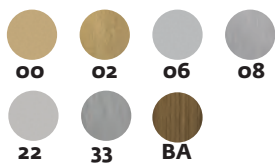

Cieca / Latch Ohne Schlüssel / BDC	Patent / Lock BB / Cle L	Yale / Cylinder PZ / Cle I	WC / Privacy BAD / Cond/Dec
R22948	R22948	R22948	R22948
	B57 - 57 mm	D55 - 55 mm	I57 - 57 mm
	B70 - 70 mm	D57 - 57 mm	I63 - 63 mm
	B72 - 72 mm	D70 - 70 mm	I70 - 70 mm
	B75 - 75 mm	D72 - 72 mm	I78 - 78 mm
	B90 - 90 mm	D85 - 85 mm	I90 - 90 mm
	B11 - 110 mm	D92 - 92 mm	I11 - 110 mm
		D11 - 110 mm	
Altre distanze a richiesta / Other distances on request / Weitere Entfernungen auf Anfrage / D'autres distances sur demande			
000	BXX	DXX	IXX



finiture standard / standard finishes
Standardveredelungen / finitions standards

00 - Oro / Polished brass Messing poliert / Laiton poli	•	•	•	•
02 - Ottone satinato / Satin brass Messing matt / Laiton satiné	•	•	•	•
06 - Cromo lucido / Polish. chrome Chrom / Chrome poli	•	•	•	•
08 - Cromo satinato / Sat. chrome Chrom matt / Chrome satiné	•	•	•	•
22 - Nickel lucido / Polished nickel Nickel / Nickel poli	•	•	•	•
33 - Nickel sat. vern. / Satin nickel Nickel matt / Nickel satiné	•	•	•	•
BA - Bronzo gr. opaco Mat satin bronze Matt satin Bronze Bronze mat satiné	•	•	•	•

Elba

Placche / Plates / Langschild / Plaques

Grado

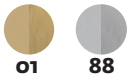

Cieca / Latch Ohne Schlüssel / BDC	Patent / Lock BB / Cle L	Yale / Cylinder PZ / Cle I	WC / Privacy BAD / Cond/Dec
R22945	R22945	R22945	R22945
	B57 - 57 mm	D55 - 55 mm	I57 - 57 mm
	B70 - 70 mm	D57 - 57 mm	I63 - 63 mm
	B72 - 72 mm	D70 - 70 mm	I70 - 70 mm
	B75 - 75 mm	D72 - 72 mm	I78 - 78 mm
	B90 - 90 mm	D85 - 85 mm	I90 - 90 mm
	B11 - 110 mm	D92 - 92 mm	I11 - 110 mm
		D11 - 110 mm	
Altre distanze a richiesta / Other distances on request / Weitere Entfernungen auf Anfrage / D'autres distances sur demande			
000	BXX	DXX	IXX



finiture standard / standard finishes
Standardveredelungen / finitions standards

01 - Bi-oro / Polished + satin brass
Messing poliert + matt
Laiton poli + satiné

88 - Bi-cromo / Polish. + sat. chrome
Chrom + Chrom matt
Chrome poli + chrome satiné

•	•	•	•
•	•	•	•

Grado

Placche / Plates / Langschild / Plaques Quadra

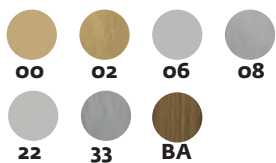

Cieca / Latch Ohne Schlüssel / BDC	Patent / Lock BB / Cle L	Yale / Cylinder PZ / Cle I	WC / Privacy BAD / Cond/Dec
R22901	R22901	R22901	R22901
	B57 - 57 mm	D55 - 55 mm	I57 - 57 mm
	B70 - 70 mm	D57 - 57 mm	I63 - 63 mm
	B72 - 72 mm	D70 - 70 mm	I70 - 70 mm
	B75 - 75 mm	D72 - 72 mm	I78 - 78 mm
	B90 - 90 mm	D85 - 85 mm	I90 - 90 mm
	B11 - 110 mm	D92 - 92 mm	I11 - 110 mm
		D11 - 110 mm	
Altre distanze a richiesta / Other distances on request / Weitere Entfernungen auf Anfrage / D'autres distances sur demande			
000	BXX	DXX	IXX



finiture standard / standard finishes
Standardveredelungen / finitions standards

00 - Oro / Polished brass Messing poliert / Laiton poli	•	•	•	•
02 - Ottone satinato / Satin brass Messing matt / Laiton satiné	•	•	•	•
06 - Cromo lucido / Polish. chrome Chrom / Chrome poli	•	•	•	•
08 - Cromo satinato / Sat. chrome Chrom matt / Chrome satiné	•	•	•	•
22 - Nickel lucido / Polished nickel Nickel / Nickel poli	•	•	•	•
33 - Nickel sat. vern. / Satin nickel Nickel matt / Nickel satiné	•	•	•	•
BA - Bronzo gr. opaco Mat satin bronze Matt satin Bronze Bronze mat satiné	•	•	•	•

Quadra

Placche / Plates / Langschild / Plaques Panda

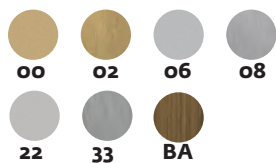

Cieca / Latch Ohne Schlüssel / BDC	Patent / Lock BB / Cle L	Yale / Cylinder PZ / Cle I	WC / Privacy BAD / Cond/Dec
R22920	R22920	R22920	R22920
	B57 - 57 mm	D55 - 55 mm	I57 - 57 mm
	B70 - 70 mm	D57 - 57 mm	I63 - 63 mm
	B72 - 72 mm	D70 - 70 mm	I70 - 70 mm
	B75 - 75 mm	D72 - 72 mm	I78 - 78 mm
	B90 - 90 mm	D85 - 85 mm	I90 - 90 mm
	B11 - 110 mm	D92 - 92 mm	I11 - 110 mm
		D11 - 110 mm	
Altre distanze a richiesta / Other distances on request / Weitere Entfernungen auf Anfrage / D'autres distances sur demande			
000	BXX	DXX	IXX



finiture standard / standard finishes
Standardveredelungen / finitions standards

00 - Oro / Polished brass Messing poliert / Laiton poli	•	•	•	•
02 - Ottone satinato / Satin brass Messing matt / Laiton satiné	•	•	•	•
06 - Cromo lucido / Polish. chrome Chrom / Chrome poli	•	•	•	•
08 - Cromo satinato / Sat. chrome Chrom matt / Chrome satiné	•	•	•	•
22 - Nickel lucido / Polished nickel Nickel / Nickel poli	•	•	•	•
33 - Nickel sat. vern. / Satin nickel Nickel matt / Nickel satiné	•	•	•	•
BA - Bronzo gr. opaco Mat satin bronze Matt satin Bronze Bronze mat satiné	•	•	•	•

Panda

Placche per esterno senza fori viti / Outside plates without screw holes
 Außenplatten ohne Bohrlöcher / Plaques pour extérieur sans trous vis

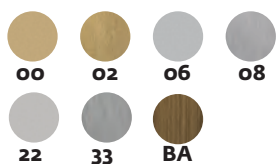

Cieca / Latch / BDC	Cieca / Latch / BDC
R22905	R22902
000	000



finiture standard / standard finishes
 Standardveredelungen / finitions standards

00 - Oro / Polished brass Messing poliert / Laiton poli	•	•
02 - Ottone satinato / Satin brass Messing matt / Laiton satiné	•	•
06 - Cromo lucido / Polish. chrome Chrom / Chrome poli	•	•
08 - Cromo satinato / Sat. chrome Chrom matt / Chrome satiné	•	•
22 - Nickel lucido / Polished nickel Nickel / Nickel poli	•	•
33 - Nickel sat. vern. / Satin nickel Nickel matt / Nickel satiné	•	•
BA - Bronzo gr. opaco Mat satin bronze Matt satin Bronze Bronze mat satiné	•	•

Sidney

Quadra

Alzanti scorrevoli / Pull up handles for sliding doors Hebe- Schiebetürgriff / Poignées pour portes coulissantes

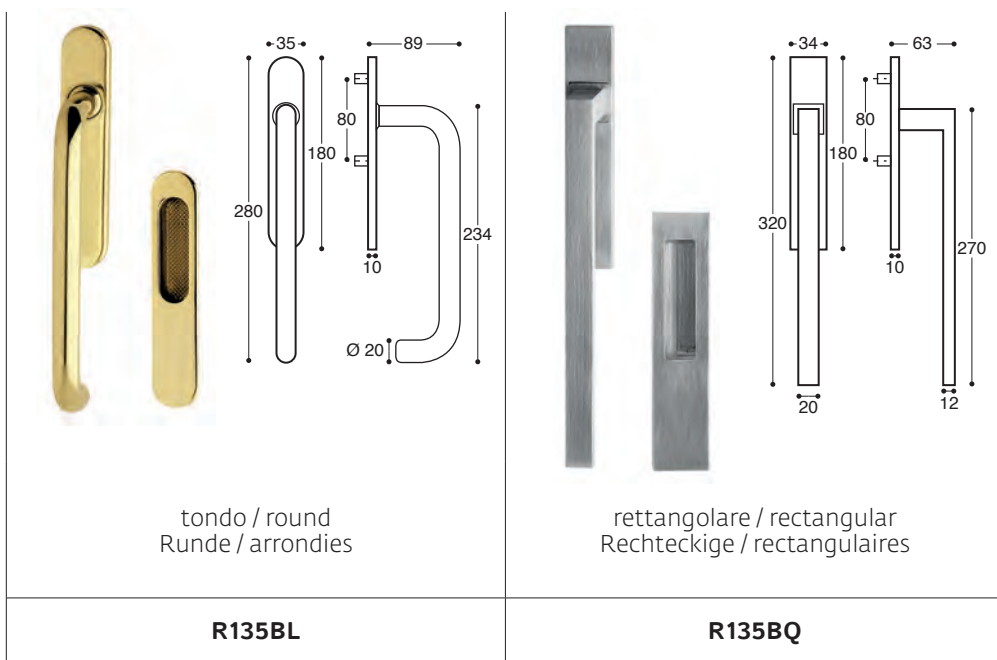
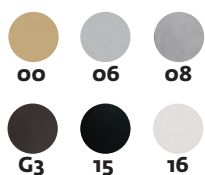

finiture standard / standard finishes
Standardveredelungen / finitions standards

00 - Oro / Polished brass Messing poliert / Laiton poli	•	•
06 - Cromo lucido / Polish. chrome Chrom / Chrome poli	•	•
08 - Cromo satinato / Sat. chrome Chrom matt / Chrome satiné	•	•
finiture trendy / trendy finishes Trendy Veredelungen / finitions trendy		
G3 - Gun metal	•	•
15 - Nero opaco* / Mat black* Matt schwarz* / Noir mat*	•	•
16 - Bianco* / White* Weiß* / Blanc*	•	•

Tondo

Rettangolare

* a richiesta / on demand / auf Anfrage / sur demande

Serramenti / Window frames / Fenster und Türen / Serrures

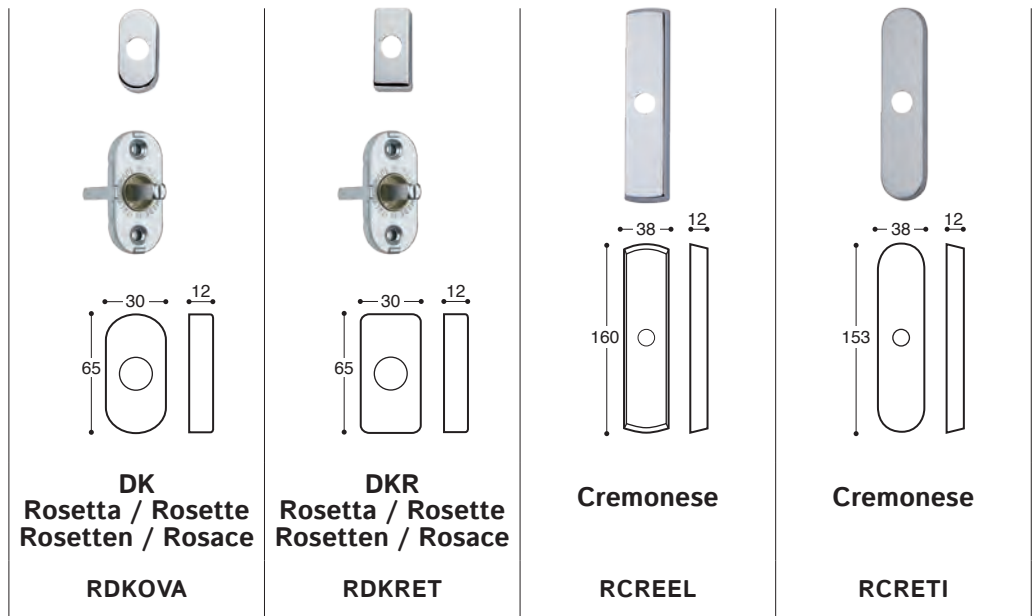
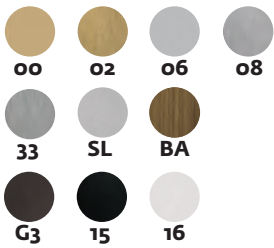

finiture standard / standard finishes
Standardveredelungen / finitions standards

00 - Oro / Polished brass Messing poliert / Laiton poli	•	•	•	•
06 - Cromo lucido / Polish. chrome Chrom / Chrome poli	•	•	•	•
08 - Cromo satinato / Sat. chrome Chrom matt / Chrome satiné	•	•	•	•
33 - Nickel sat. vern. / Satin nickel Nickel / Nickel satiné	•	•	•	•
SL - Silver / Silber	•	•	•	•
BA - Bronzo gr. opaco / Mat sat. bronze Matt Sat. Bronze Bronze mat sat.	•	•	•	•

finiture trendy / trendy finishes
Trendy Veredelungen / finitions trendy

G3 - Gun metal	•	•	•	•
15 - Nero opaco* / Mat black* Matt schwarz* / Noir mat*	•	•	•	•
16 - Bianco* / White* Weiß* / Blanc*	•	•	•	•

Ovale Rettangolare Elba Tike

* a richiesta / on demand / auf Anfrage / sur demande

Meccanismo 8 scatti
per microventilazione
Mechanism 8 shots for
microventilation
8-facher Mechanismus
für Mikroventilation
Mécanisme 8 déclenchements
pour micro ventilation

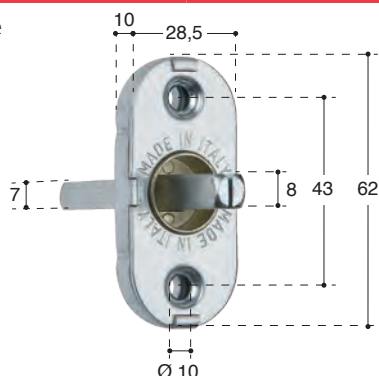

Serramenti / Window frames / Fenster und Türen / Serrures

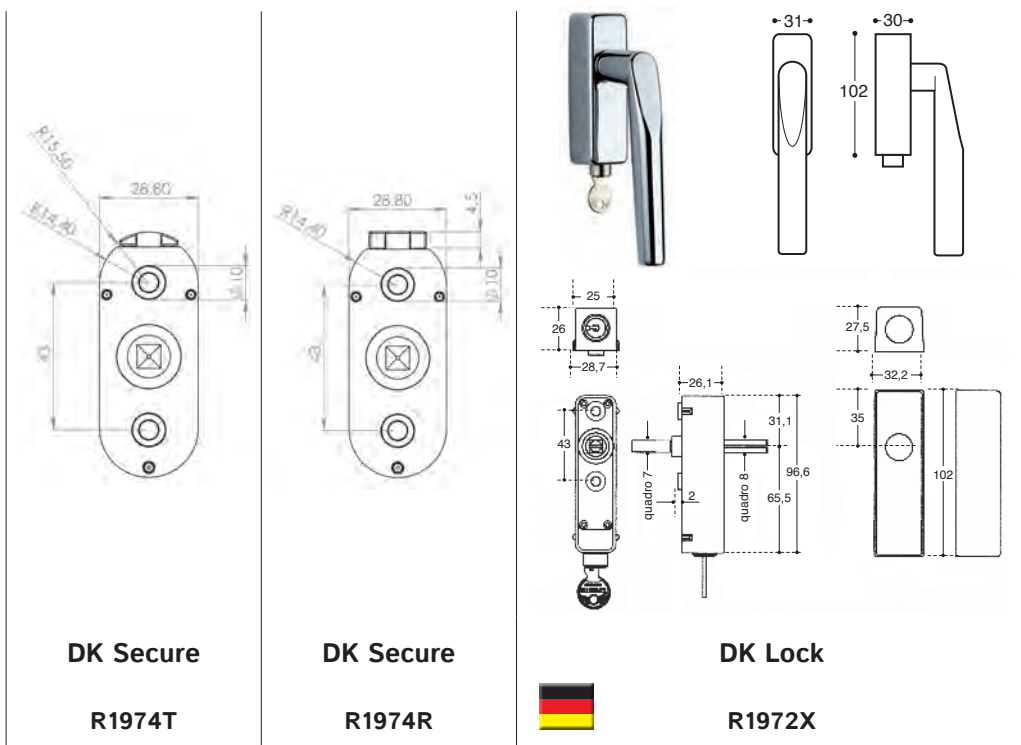
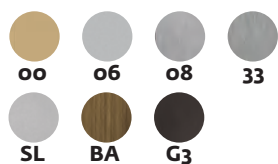

finiture standard / standard finishes
Standardveredelungen / finitions standards

oo - Oro / Polished brass Messing poliert / Laiton poli	•	•	•
o6 - Cromo lucido / Polish. chrome Chrom / Chrome poli	•	•	•
o8 - Cromo satinato / Sat. chrome Chrom matt / Chrome satiné	•	•	•
33 - Nickel sat. vern. / Satin nickel Nickel / Nickel satiné	•	•	•
SL - Silver / Silber	•	•	•
BA - Bronzo gr. opaco Mat satin bronze Matt satin Bronze Bronze mat satiné	•	•	•

finiture trendy / trendy finishes
TrendyVeredelungen / finitions trendy

G3 - Gun metal	•	•	•
-----------------------	---	---	---

DK secure

DK secure

DK lock



Ferri / Spindles / Stift / Mécanismes

standard			codice / code Kode / code
	Ferro ad espansione Screw fastening spindle Spreizstift Carré avec vis	8 x 65 8 x 45	R1B96500000 R1B9658X045
	Ferro 2 tagli-2 fresate Spindle 2 cuts-2 milled Stift mit 2 Schnitte-2 Fräsungen Carré 2 coupes-2 fraiseuses	8 x 85 8 x 95 8 x 100 8 x 110 8 x 120 8 x 130	R1B9628X085 R1B9628X095 R1B9628X100 R1B9628X110 R1B9628X120 R1B9628X130
	Ferro / Spindle / Stift / Carré	8 x 90 8 x 100 8 x 120 8 x 135 8 x 150	R1B9688X090 R1B9688X100 R1B96800000 R1B9688X135 R1B9688X150
	Ferro 2 tagli-2 fresate Spindle 2 cuts-2 milled Stift mit 2 Schnitte-2 Fräsungen Carré avec 2 coupes + 2 fraises	7 x 95 7 x 100	R1B9647X095 R1B9647X100
	Ferro / Spindle / Stift / Carré	7 x 70	R1B96600000
	Ferro con rondella Spindle with washer Stift mit Unterlegscheibe Carré avec rondelle	7 x 80	R1B9667X080
	Ferro con 1 fresatura Spindle with 1 milled Stift mit 1 Schnitte Carré avec fraiseuse	6 x 32 6 x 35 6 x 80	R1B9616X032 R1B9616X035 R1B9616X080
	Ferro / Spindle / Stift / Carré	6 x 100	R1B96700000
	Ferro con 1 taglio e 1 fresata Spindle 1 cut 1 milled Stift mit 1 Schnitte-1 Fräsung Carré 1 coupe-1 fraiseuse	7 x 80	R1B9697X080
	Ferro Dummy / Dummy spindle Dummy Stift / Carré dummy	Q.8	R4T10013
	Dummy filettato Threaded dummy Dummy mit Gewinde Dummy fileté	M8	R4T10039
	Dummy tondo per fissaggio frontale di maniglioni e pomoli Round dummy for pulls and knobs face fixing Runder Dummy für Türgriff-und Knopfflächenbefestigung Dummy rond pour la fixation des poignées et des boutons	Ø 8 mm	R4T10026
	Troncone filettato e dado per fissaggio passante Passing through bolt and nut Gewindestab und Mutter für interne Befestigung Partie fileté et écrou pour fixation passante	10 x 100	R4F110 + codice finitura dado
	Troncone per fissaggio UG Back-to-back bolt Stab für paarweise Befestigung Partie pour fixation UG	10 x 100	R4G03056

Movimenti / Mechanisms / Mechanismus / Mécanismes

 	codice / code Kode / code
	Tipo A - DK 7 x 42 - 8 scatti R1B96000000
	Tipo C - Gratz con bussole + Q.7 R1971009
	Tipo D - Gratz con perni R1971019
	Tipo E - Gratz con bussole R1971020
	Tipo F - Martellina + Q.7 R1971031
	Tipo G - Gratz con bussole + Q.7 R1971026
	Tipo H - Gratz con perni R1971027
	Tipo I - Gratz con bussole R1971025
	DK Secure R1974XSS
	Serratura per DK con chiave Window DK lock with key DK Fenster mit Schlüssel Serrure pour DK avec clé R1972XXX

Strumenti punto vendita / Point of Sale Tools
 Instrumente Verkaufsstandort / Instruments point de vente



Pannello espositore
 Display board
 Ausstellungstafel
 Panneau exposant

42 x 90 cm



Poster punto vendita
 Selling point poster
 Poster Verkaufsstandort
 Poster point de vente

30 x 60 cm



Valigetta campionario
 Show case
 Musterkofferchen
 Valisette d'échantillons



Finiture disponibili / Finishes available / Verfügbare Veredelungen
 Finitions disponibles



00 - Oro
 Polished brass
 Messing poliert
 Laiton poli



02 - Ottone satinato
 Satin brass
 Messing matt
 Laiton satiné



06 - Cromo lucido
 Polished chrome
 Chrom
 Chrome poli



08 - Cromo satinato
 Satin chrome
 Chrom matt
 Chrome satiné



22 - Nickel lucido
 Polished nickel
 Nickel poliert
 Nickel poli



33 - Nickel satinato verniciato
 Satin nickel
 Nickel satiniert lackiert
 Nickel satiné verni



34 - Nickel satin. vern. opaco
 Satin nickel matt lacquered
 Nickel satiniert lackiert matt
 Nickel satiné verni mat



SL - Silver
 Silber



BA - Bronzo graffiato opaco
 Mat satin bronze
 Matt satin Bronze
 Bronze mat satiné



BR - Bronzo opaco
 Mat bronze
 Matt Bronze
 Bronze mat



ON - Ottone naturale
 Natural brass
 Messing nature
 Laiton naturelle



03 - Oro 24K
 Gold 24K
 Or 24K



G3 - Gun metal



15 - Nero opaco
 Mat black
 Matt schwarz
 Noir mat



16 - Bianco
 White
 Weiß
 Blanc

Mano maniglie / Hand of handles / Hand der Griffe / Main poignées

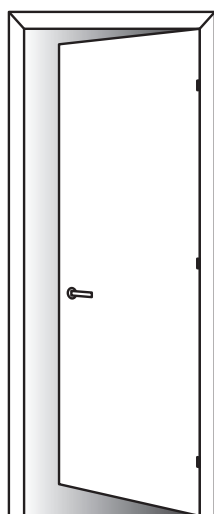

Maniglia DESTRA, cerniere a destra, si impugna con la mano destra per aprire (sia a tirare che a spingere).

RIGHT handle, hinges on the right, you hold with your right hand to open (both pulling and pushing).

RECHTER Griff, Scharnier rechts, wird mit der rechten Hand geöffnet (sowohl ziehen als auch drücken).

Poignée DROITE, charnière à droite, on la saisit de la main droite pour ouvrir (Aussi bien pour tirer que pour pousser).

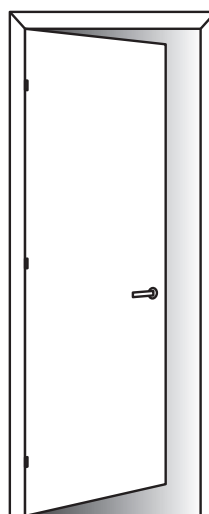

Maniglia SINISTRA, cerniere a sinistra, si impugna con la mano sinistra per aprire (sia a tirare che a spingere).

LEFT handle, hinges on the left, you hold with your left hand to open (both pulling and pushing).

LINKER Griff, Scharnier links, wird mit der linken Hand geöffnet (sowohl ziehen als auch drücken).

Poignée GAUCHE, charnière à gauche, on la saisit de la main gauche pour ouvrir (Aussi bien pour tirer que pour pousser).

Fissaggio maniglioni / Pulls installation / Tuergriffen Befestigung / Montage des tirants

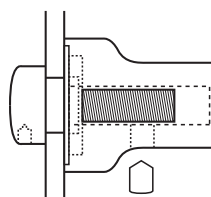

1 - Fissaggio con troncone passante
Fixing with stump through
Interne Befestigung mit Stab
Fixation avec partie passante

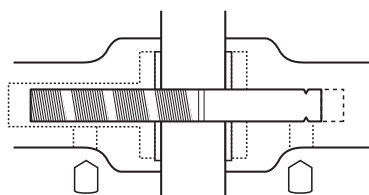

2 - Fissaggio UG per paio maniglioni
UG fixing for two handlebars
Paarweise Satzbelegung
Fixation UG pour paires de poignées

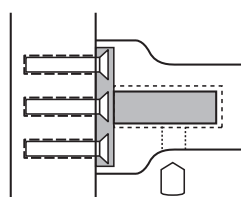

3 - Fissaggio frontale con base "dummy"
Frontal fixation with "dummy" base
Befestigung vorne mit Basis "dummy"
Fixation frontale avec base « dummy »



GIARA S.r.l.

Via San Lino, 47 - 25071 AGNOSINE (BS) - Italy

Tel. +39.0365.860539 / 823030

Fax +39.0365.869366 / 839908

e-mail info@giara.info

www.rdshandles.it